

WATER IS OUR ORIGIN



 **SCHÜTTE**
ARMATUREN UND BRAUSEN SEIT 1976



AKZENTE IN KÜCHE UND BAD

EN | HIGHLIGHTS IN KITCHEN
AND BATHROOM

FR | VEDETTES EN CUISINE ET
DANS LA SALLE DE BAIN

NL | HIGHLIGHTS IN KEUKEN
EN BADKAMER

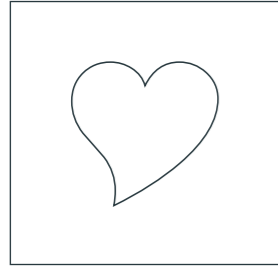

Unsere Leidenschaft für Qualität und Verantwortung.

Als Familienunternehmen stehen wir für hochwertige Sanitärlösungen, die das tägliche Leben verbessern. Mit weltweit nach deutschen Standards produzierten Produkten bieten wir Ihnen innovative und flexible Lösungen mit einem optimalen Preis-Leistungs-Verhältnis. Als verantwortungsvoller Arbeitgeber und zuverlässiger Partner legen wir höchsten Wert auf Ehrlichkeit, Vertrauen, sowie die Zufriedenheit unserer Mitarbeiter und Kunden. Gemeinsam schaffen wir Räume, in denen Sie sich wohlfühlen.

EN | As a family-run business, we stand for high-quality sanitary solutions that improve everyday life. With products manufactured worldwide to German standards, we offer you innovative and flexible solutions with an optimal price-performance ratio. As a responsible employer and reliable business partner, we value honesty, trust and the satisfaction of our employees and customers. Together, we create spaces in which you feel at home.

FR | En tant qu'entreprise familiale, nous sommes synonymes de solutions sanitaires de qualité supérieure qui améliorent la vie quotidienne. Avec des produits fabriqués dans le monde entier selon les normes allemandes, nous vous proposons des solutions innovantes et flexibles avec un rapport performance-prix optimal. En tant qu'employeur responsable et partenaire commercial fiable, nous accordons une grande importance à l'honnêteté, à la confiance et à la satisfaction de nos collaborateurs et clients. Ensemble, nous créons des espaces dans lesquels il fait bon vivre.

NL | Als familiebedrijf staan wij voor hoogwaardige sanitair oplossingen die het dagelijkse leven verbeteren. Met producten die wereldwijd geproduceerd worden volgens Duitse normen, bieden wij u innovatieve en flexibele oplossingen met een optimale prijs-prestatie verhouding. Als verantwoordelijke werkgever en betrouwbare zakenpartner staan eerlijkheid, vertrouwen en de tevredenheid van onze medewerkers en klanten bij ons bovenaan. Samen creëren we ruimtes waarin u zich thuis voelt.

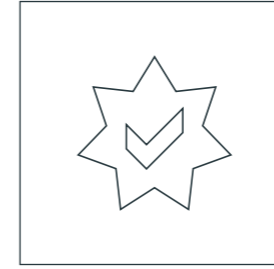

Qualität, die hält, was sie verspricht.

Unsere Produkte stehen für Beständigkeit, Zuverlässigkeit und perfekte Funktionalität. Seit jeher werden sie in unserem hauseigenen Labor intensiv auf Funktion, Materialqualität und Belastbarkeit geprüft. Durch ständige Tests und Innovationen in unserem Labor in Wallenhorst stellen wir sicher, dass unsere Armaturen Ihnen über viele Jahre Freude bereiten – für Qualität, auf die Sie sich verlassen können.

EN | Our products stand for durability, reliability and perfect functionality. They have always been extensively tested regarding function, material quality and resilience in our in-house laboratory. Through constant testing and innovation, we ensure that our taps will give you many years of pleasure - quality you can rely on.

FR | Nos produits sont synonymes de durabilité, de fiabilité et de fonctionnalité parfaite. Depuis toujours, ils sont soumis à des tests intensifs dans notre propre laboratoire pour vérifier leur fonctionnement, la qualité des matériaux et leur résistance. Grâce à des tests rigoureux et des innovations permanentes, nous garantissons que nos mitigeurs vous donneront satisfaction pendant de nombreuses années – une qualité sur laquelle vous pouvez compter.

NL | Onze producten staan voor duurzaamheid, betrouwbaarheid en perfecte functionaliteit. Ten alle tijden worden ze in ons eigen laboratorium intensief getest op functionaliteit, materiaalkwaliteit en duurzaamheid. Door voortdurend te testen en te innoveren, zorgen we ervoor dat je jarenlang plezier hebt van onze kranen – voor kwaliteit waarop je kunt vertrouwen.



Langlebigkeit, auf die Sie vertrauen können.

Unsere Armaturen und Duschen stehen für Qualität und Beständigkeit – deshalb bieten wir Ihnen eine **5-jährige Garantie**, die unsere Überzeugung in ihre Haltbarkeit und Zuverlässigkeit unterstreicht. Damit Sie auch in Zukunft abgesichert sind, gewähren wir zusätzlich eine 10-jährige Nachkaufgarantie auf Ersatzteile. So können Sie sich langfristig auf uns und unsere Produkte verlassen.

EN | Our faucets and showers stand for quality and durability – which is why we offer you a **5-year guarantee** that emphasizes our conviction in their durability and reliability. To ensure that you are also protected in the future, we also offer a 10-year guarantee on spare parts availability. So you can rely on us and our products for the long term.

FR | Nos mitigeurs et douches sont synonymes de qualité et de durabilité. C'est pourquoi nous vous offrons **garantie de 5 ans**, qui souligne notre conviction dans leur durabilité et leur fiabilité. Pour que vous soyez également couvert à l'avenir, nous accordons en outre une garantie de 10 ans sur la disponibilité de pièces de rechange. Vous pouvez ainsi compter sur nous et sur nos produits à long terme.

NL | Onze kranen en douches staan voor kwaliteit en duurzaamheid – daarom bieden we je een **garantie van 5 jaar** die onze overtuiging in hun duurzaamheid en betrouwbaarheid benadrukt. Om ervoor te zorgen dat je ook in de toekomst beschermd bent, bieden we 10 jaar garantie op de beschikbaarheid van onderdelen. Je kunt dus op lange termijn op ons en onze producten vertrouwen.

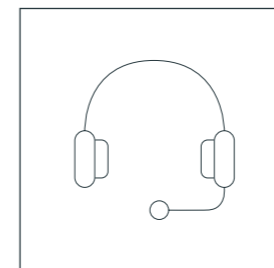

Wir sind für Sie da

Über die Service-Hotline (+49 54 07 / 87 07 - 100) oder per Mail (service@fjschuette.com) erreichen Sie unsere geschulten MitarbeiterInnen, die Sie umfassend beraten. Vom Ersatzteilversand bis hin zur Montageanleitung unterstützen wir Sie jederzeit. Sprechen Sie uns an!

EN | Via the service hotline (+49 54 07 / 87 07 - 100) or by e-mail (service@fjschuette.com) you can reach our well-trained staff, who will provide you with all the information you need. From the dispatch of spare parts to installation instructions, we will always support you. Simply get in touch with us!

FR | Via l'assistance téléphonique du service après-vente (+49 54 07 / 87 07 - 100) ou par e-mail (service@fjschuette.com), vous contactez nos équipes formées qui vous conseilleront de manière exhaustive. De l'envoi de pièces de rechange aux instructions de montage, nous vous assistons à tout moment. N'hésitez pas à nous contacter !

NL | Via de servicehotline (+49 54 07 / 87 07 - 100) of per e-mail (service@fjschuette.com) kun je onze getrainde medewerkers bereiken, die je uitgebreid advies zullen geven. Van de verzending van onderdelen tot montagehandleidingen, wij zullen u te allen tijde ondersteunen. Neem gerust contact met ons op!

50 JAHRE IN UNSEREM ELEMENT

50 YEARS · 50 ANS
IN OUR ELEMENT · DANS NOTRE ÉLEMENT

2026 feiern wir 50 Jahre SCHÜTTE und blicken auf ein halbes Jahrhundert Unternehmensgeschichte zurück. Seit 1976 haben wir uns als familiengeführtes Unternehmen kontinuierlich weiterentwickelt und unsere Kompetenz als Hersteller im Sanitärbereich stetig ausgebaut. Der Name SCHÜTTE steht für Qualität, Funktionalität und einen verantwortungsvollen Umgang mit Wasser – getragen von Erfahrung und langfristigem Denken. Unter dem Motto „50 Jahre – in unserem Element“ würdigen wir diesen Weg und richten unseren Blick weiterhin nach vorn.

EN | In 2026, we will celebrate 50 years of SCHÜTTE and look back on half a century of company history. Since 1976, we have continuously evolved as a family-owned business and steadily expanded our expertise as a manufacturer in the sanitary sector. The name SCHÜTTE stands for quality, functionality and a responsible approach to water – shaped by experience and long-term thinking. Under the motto “50 years – in our element”, we honour this journey while continuing to look ahead.

FR | En 2026, nous fêterons les 50 ans de SCHÜTTE et reviendrons sur un demi-siècle d'histoire de l'entreprise. Depuis 1976, nous n'avons cessé d'évoluer en tant qu'entreprise familiale et avons constamment élargi notre expertise en tant que fabricant dans le secteur sanitaire. Le nom SCHÜTTE est synonyme de qualité, de fonctionnalité et d'une approche responsable de l'eau, façonnée par l'expérience et une réflexion à long terme. Sous la devise « 50 ans – dans notre élément », nous rendons hommage à ce parcours tout en continuant à regarder vers l'avenir.

NL | In 2026 vieren we het 50-jarig bestaan van SCHÜTTE en kijken we terug op een halve eeuw bedrijfsgeschiedenis. Sinds 1976 hebben we ons als familiebedrijf voortdurend ontwikkeld en onze expertise als fabrikant in de sanitairsector gestaag uitgebreid. De naam SCHÜTTE staat voor kwaliteit, functionaliteit en een verantwoordelijke omgang met water – gevormd door ervaring en langetermijndenken. Onder het motto “50 jaar – in ons element” eren we deze reis en blijven we vooruitkijken.

Unsere Jubiläums-Armaturen
Franz & Joseph aus massivem Edelstahl
(verfügbar ab Mai 2026)

EN | Our anniversary taps **Franz & Joseph** made from solid stainless steel (Available from May 2026)
FR | Nos robinetteries anniversaire **Franz & Joseph** en acier inoxydable massif (Disponible à partir de mai 2026)
NL | Onze jubileumkranen **Franz & Joseph** van massief roestvrij staal (Beschikbaar vanaf mei 2026)



Franz



Joseph



› Cornwall-Serie
Seite 36

Die breite Farbvielfalt unserer Artikel ermöglicht es, jedem Raum eine ganz persönliche Note zu verleihen. Von zeitlosen Klassikern bis hin zu modernen Trendfarben – für jeden Geschmack und Stil ist das Passende dabei.

EN | The wide range of colours for our products makes it possible to give every room a very personal touch. From timeless classics to modern trend colours – there is something to suit every taste and style.

FR | La large palette de couleurs de nos articles permet de donner à chaque pièce une note très personnelle. Des classiques intemporels aux couleurs modernes et tendance, il y en a pour tous les goûts et tous les styles.

NL | Het brede kleurengamma van onze producten maakt het mogelijk om elke kamer een heel persoonlijk tintje te geven. Van tijdloze klassiekers tot moderne trendkleuren – er is iets dat bij elke smaak en stijl past.

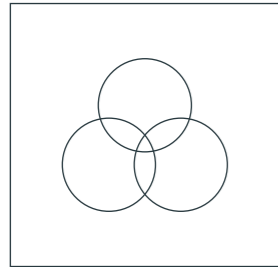

CHROM
CHROME
CHROMÉ
CHROOM



EDELSTAHOPTIK
STAINLESS STEEL LOOK
APPARENCE INOX
ROESTVRIJ STAAL LOOK



WEISS MATT
MATT WHITE
BLANC MAT
MAT WIT



SILBER / HELLGRAU
SILVER / LIGHT GREY
ARGENT / GRIS CLAIR
ZILVER / LICHTGRIJS



SCHWARZ MATT
MATT BLACK
NOIR MAT
MAT ZWART



ANTHRAZIT MATT
MATT ANTHRACITE
ANTHRACITE MAT
MAT ANTRACIET



GRAPHIT MATT
MATT GRAPHITE
GRAPHITE MAT
MAT GRAFIET



GOLD MATT
MATT GOLD
OR MAT
MAT GOUD



KUPFER MATT
MATT COPPER
CUIVRE MAT
MAT KOPER



KUPFER GLÄNZEND
COPPER GLOSSY
CUIVRE BRILLANT
KOPER GLANZEND



ROSÉ MATT
MATT ROSÉ
ROSE MAT
MAT ROSÉ

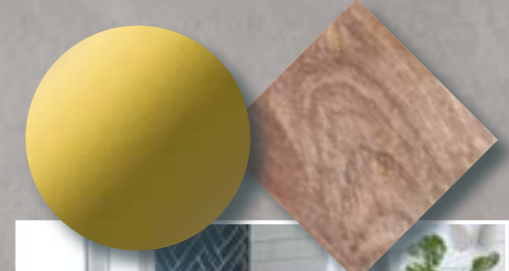



› 75800
Seite 107



› 33160
Seite 63











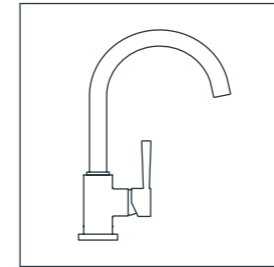



› 60044
Seite 122



› 93100
Seite 171





	NEUHEITEN INNOVATIONS NOUVEAUTÉS NIEUWIGHEDEN	17
	KÜCHENARMATUREN KITCHEN TAPS ROBINETTERIE CUISINE KEUKENKRANEN	23
	KÜCHENAUSSTATTUNG KITCHEN EQUIPMENT ÉQUIPEMENT DE CUISINE KEUKENUITRUSTING	53
	BADARMATUREN-SERIEN BATHROOM TAP SERIES SÉRIES DE MITIGEURS DE SALLE DE BAINS BADKAMERKRAAN SERIES	59
	WASCHTISCHARMATUREN WASHBASIN MIXERS MITIGEURS DE LAVABO WASTAFELKRANEN	75
	WANNENFÜLLARMATUREN BATH MIXERS MITIGEURS DE BAIN BADKRANEN	103
	DUSCHARMATUREN SHOWER MIXERS MITIGEURS DE DOUCHE DOUCHEKRANEN	109
	DUSCHPANEELE ÜBERKOPFBRAUSE-SETS STANGENBRAUSE-SETS SHOWER PANELS RAINSHOWERS SHOWER BAR SETS PANNEAUX DE DOUCHE DOUCHES DE PLUIE SETS BARRE DE DOUCHE DOUCHEPANELEN REGENDOUCHEES DOUCHESTANGSETS	115
	HANDBRAUSE-SETS HANDBRAUSEN BRAUSESCHLÄUCHE KOPFBRAUSEN HAND SHOWER SETS HAND SHOWERS SHOWER HOSES HEAD SHOWERS SETS DE DOUCHE DOUCHETTES FLEXIBLES DE DOUCHE DOUCHES DE TÊTE HANDDOUCHESETS HANDDOUCHEES DOUCHESLANGEN HOOFDDOUCHEES	139
	BADAUSSTATTUNG BATHROOM EQUIPMENT ÉQUIPEMENT DE SALLE DE BAINS BADKAMERINRICHTING	159
	DUSCH-WC SHOWER WC WC LAVANT DOUCHE WC	167
	WC-SITZE TOILET SEATS ABATTANTS WC WC-ZITTINGEN	175



Marken-Mischdüse für ein perfektes Strahlbild

EN | Brand name aerator for a perfect spray pattern
FR | Aérateur de marque pour un jet parfait
NL | Merk straalregelaar voor een perfect straalbeeld



Inkl. flexibler Anschlussschläuche

EN | Incl. flexible connection hoses
FR | Flexibles de raccordement inclus
NL | Incl. flexibele aansluitslangen

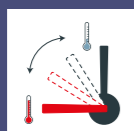

Praktische Cold-Start-Funktion

EN | Practical cold-start function
FR | Fonction pratique de démarrage à eau froide
NL | Praktische cold-start functie

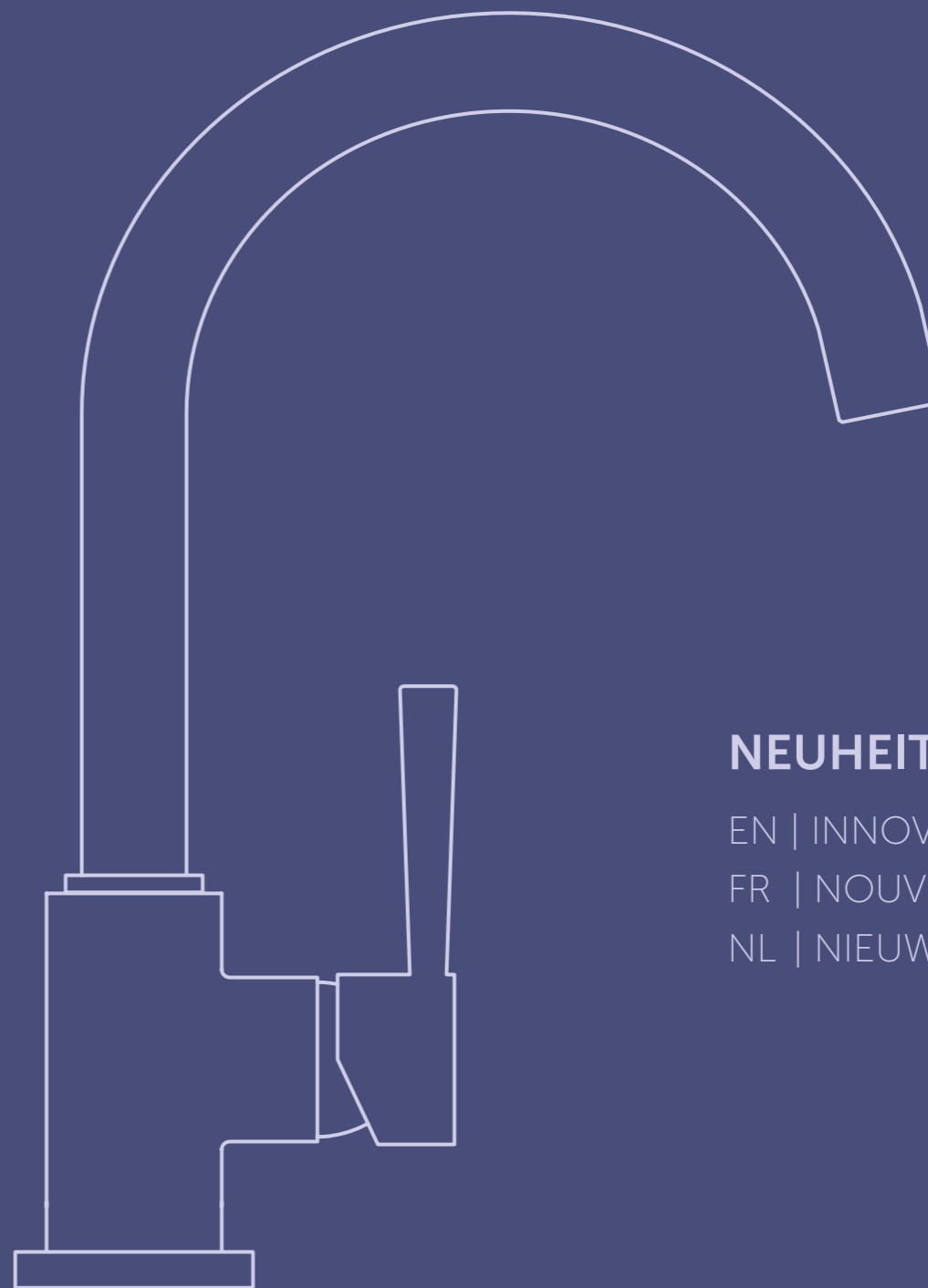

NEUHEITEN

EN | INNOVATIONS

FR | NOUVEAUTÉS

NL | NIEUWIGHEDEN

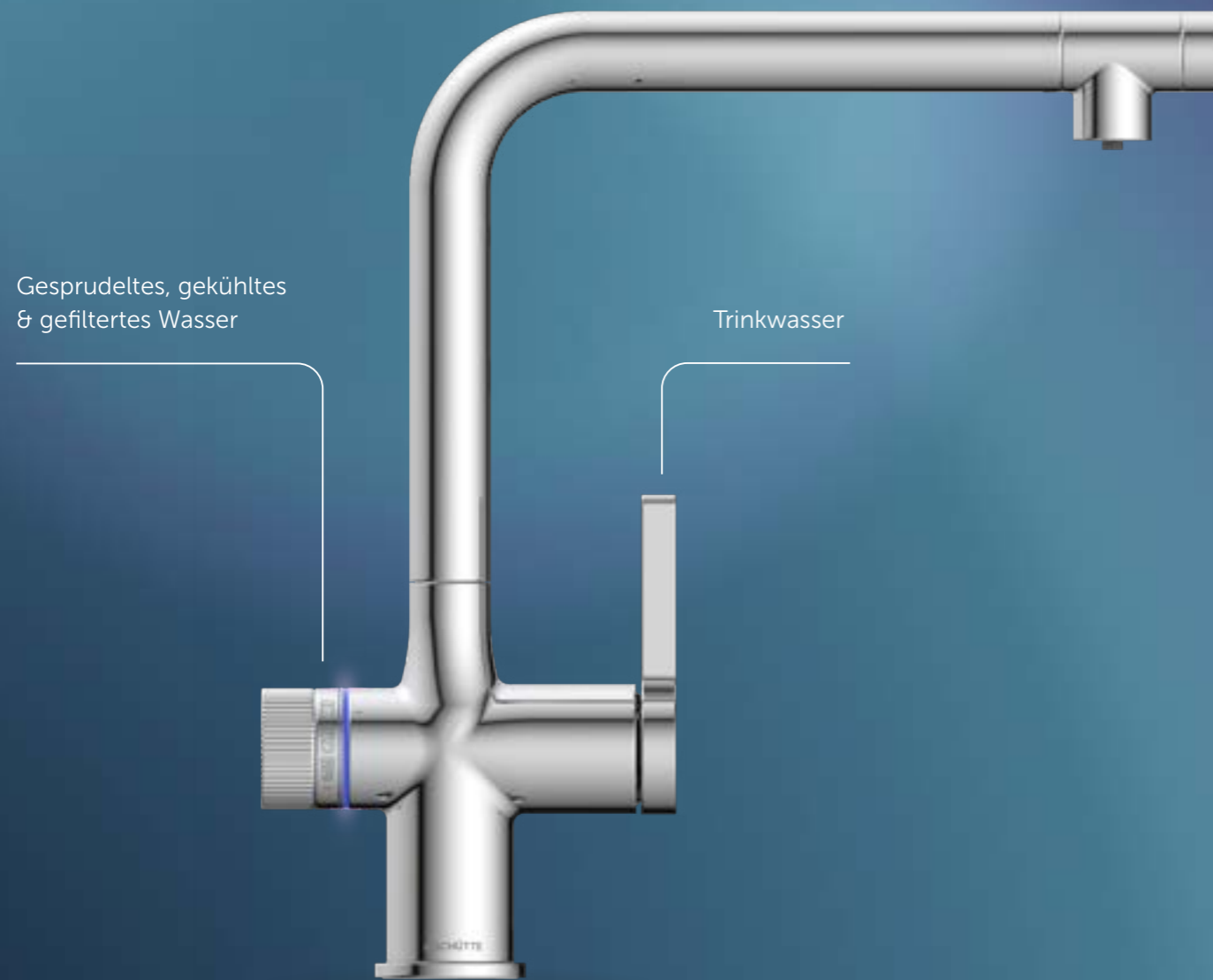

AQUASTAR PREMIUM

Erleben Sie gesprudelt, gekühlt und gefiltertes Wasser – alles aus einer Armatur! Unsere **AQUASTAR PREMIUM** ist mit einem intelligenten System ausgestattet, das es Ihnen ermöglicht, die Wasserfunktionen bequem zu wechseln und so Ihren individuellen Vorlieben gerecht zu werden.

EN | Experience sparkling, chilled and filtered water – all from one tap! Our **AQUASTAR PREMIUM** is equipped with an intelligent system that allows you to conveniently change the type of water to suit your individual preferences.

FR | Découvrez l'eau pétillante, réfrigérée et filtrée – le tout à partir d'un seul mitigeur ! Notre **AQUASTAR PREMIUM** est équipé d'un système intelligent qui vous permet de changer facilement de type d'eau et de répondre ainsi à vos préférences individuelles.

NL | Ervaar bruisend, gekoeld en gefilterd water – allemaal uit één kraan! Onze **AQUASTAR PREMIUM** is uitgerust met een intelligent systeem waarmee je het type water gemakkelijk kunt aanpassen aan je individuele voorkeuren.



AQUASTAR PREMIUM

● 99900 4008431999005



● 99905 4008431999050



● 99960 4008431999609

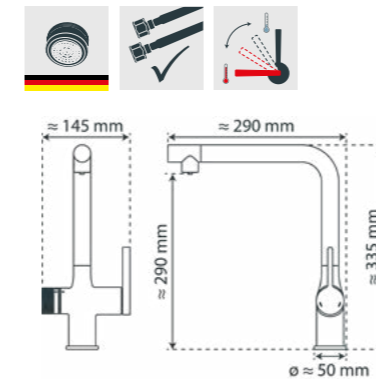

BWT FILTER
 W 1202844
 4008431028446

CO₂-KARTUSCHE
 ● 1203202
 4008431032023





AQUASTAR PRO

Die **AQUASTAR PRO** ist Küchenarmatur und Wasserfilter in einem. Eine separate Wasserführung sorgt für gesundes, gefiltertes Trinkwasser auf der einen Seite und ungefiltertes Trinkwasser für viele alltägliche Anwendungen auf der anderen Seite.

EN | The **AQUASTAR PRO** is a kitchen tap and water filter in one. A separate water supply ensures healthy, filtered drinking water on the one hand and unfiltered drinking water for many everyday uses on the other.

FR | **AQUASTAR PRO** est à la fois un mitigeur de cuisine et un filtre à eau. Une conduite d'eau séparée garantit une eau potable saine et filtrée d'une part, et une eau potable non filtrée pour de nombreuses applications quotidiennes d'autre part.

NL | De **AQUASTAR PRO** is een keukenkraan en waterfilter in één. Een gescheiden watertoevoer zorgt enerzijds voor gezond, gefilterd drinkwater en anderzijds voor ongefilterd drinkwater voor vele dagelijkse toepassingen.



AQUASTAR PRO

● 99800 4008431998008



● 99805 4008431998053



● 99860 4008431998602

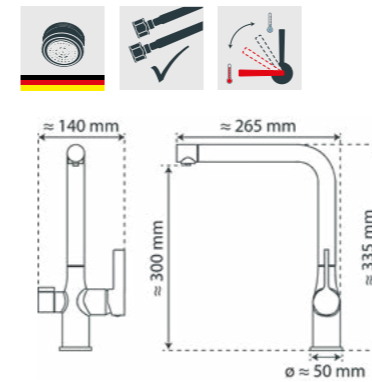

BWT FILTER

W 1202844
4008431028446





Marken-Mischdüse für ein perfektes Strahlbild

EN | Brand name aerator for a perfect spray pattern
FR | Aérateur de marque pour un jet parfait
NL | Merk straalregelaar voor een perfect straalbeeld



Inkl. flexibler Anschlusschläuche

EN | Incl. flexible connection hoses
FR | Flexibles de raccordement inclus
NL | Incl. flexibele aansluitslangen



Wassersparende Eco-Click-Funktion

EN | Water-saving eco-click function
FR | Fonction éco-clic économisant l'eau
NL | Waterbesparende eco-klik functie

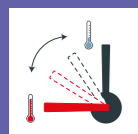

Praktische Cold-Start-Funktion

EN | Practical cold-start function
FR | Fonction pratique de démarrage à eau froide
NL | Praktische cold-start functie



Langlebig und robust durch massiven Edelstahl

EN | Durable and robust due to solid stainless steel
FR | Durable et robuste grâce à l'acier inoxydable massif
NL | Duurzaam en robuust dankzij massief roestvrij staal



Ausladung der Armatur ca. x mm

EN | Salience approx. x mm
FR | Saillie env. x mm
NL | Uitsteeksel ca. x mm

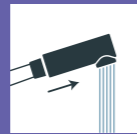

Mit herausziehbarem Auslauf

EN | With pull-out spout
FR | Avec bec extractible
NL | Met uittrekbare uitloop

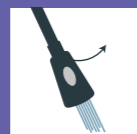

Mit herausziehbarer Geschirrbrause

EN | With pull-out sprayer
FR | Avec douchette extractible
NL | Met uittrekbare sproeier

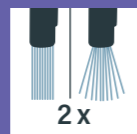

2-fach verstellbare Geschirrbrause

EN | Shower with 2 sprays
FR | Douchette avec 2 jets
NL | Sproeier met 2 straalsoorten



Berührungslose Infrarottechnologie

EN | Non-contact infrared technology
FR | Technologie infrarouge sans contact
NL | Contactloze infraroodtechnologie



Nur geeignet für drucklose Untertischgeräte

EN | Only suitable for small low pressure water heaters
FR | Convient uniquement aux petits chauffe-eau basse pression
NL | Alleen geschikt voor kleine lage druk boilers

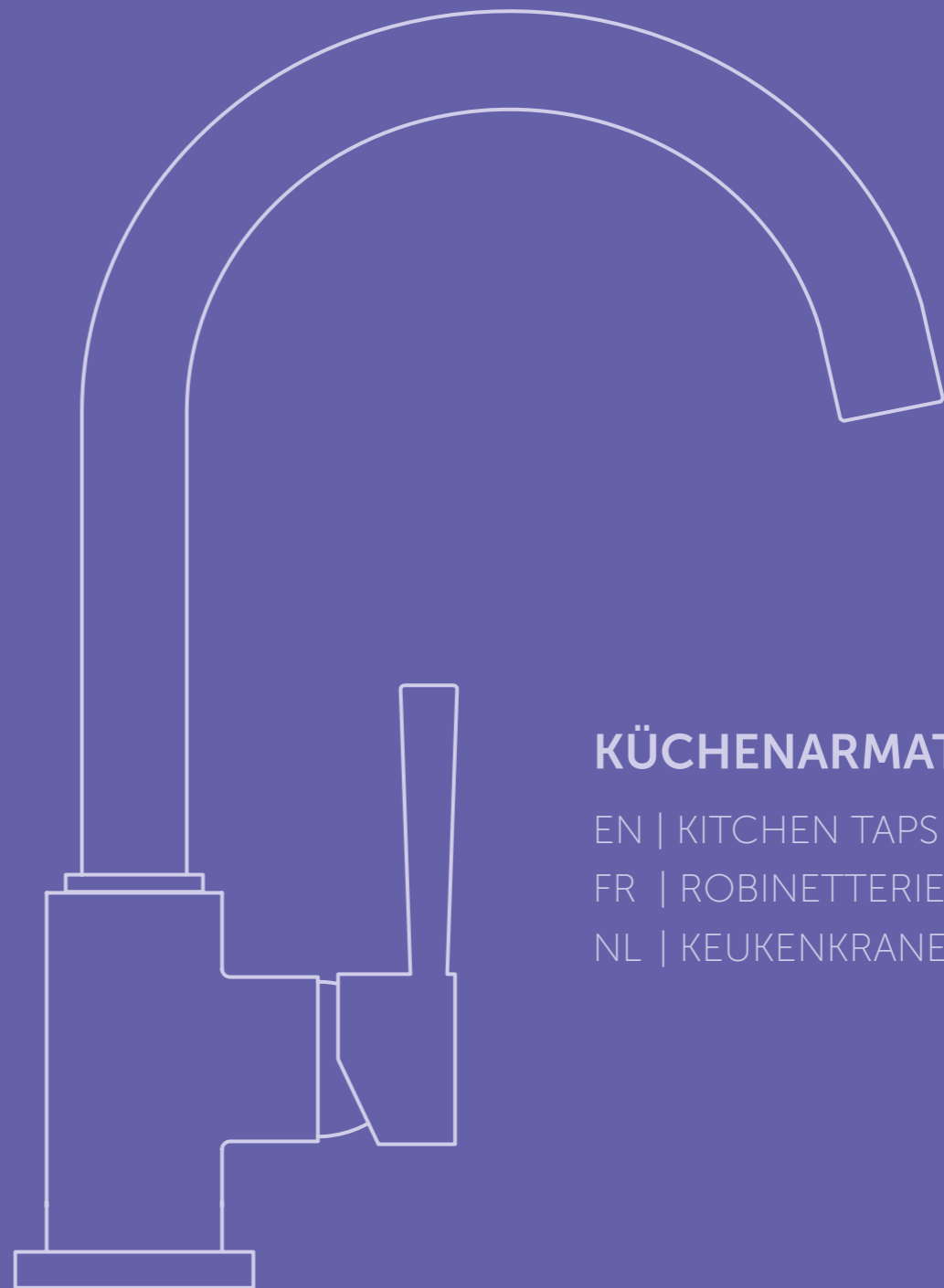

KÜCHENARMATUREN

EN | KITCHEN TAPS

FR | ROBINETTERIE CUISINE

NL | KEUKENKRANEN

> 79147
Seite 31





FRANZ

- 79405U 4008431794051
- S 79406U 4008431794068

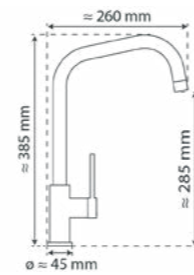

Verfügbar ab Mai 2026 | Available from May 2026
 Disponible à partir de mai 2026 | Beschikbaar vanaf mei 2026



JOSEPH

- 79475U 4008431794754
- S 79476U 4008431794761

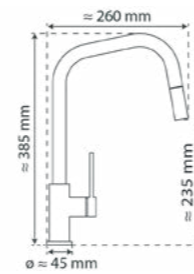

Verfügbar ab Mai 2026 | Available from May 2026
 Disponible à partir de mai 2026 | Beschikbaar vanaf mei 2026



AQUASTAR PREMIUM

- 99900 4008431999005
- 99905 4008431999050
- S 99960 4008431999609

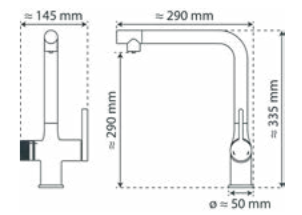
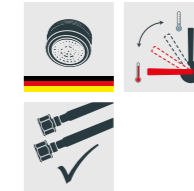

AQUASTAR PRO

- 99800 4008431998008
- 99805 4008431998053
- S 99860 4008431998602

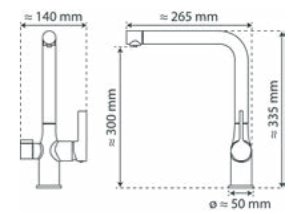
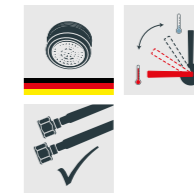

VITAL

- 99700 4008431997001
- 99705 4008431997056
- S 99760 4008431997605

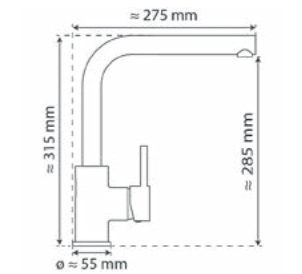
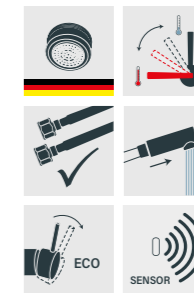



WINDOW

- 24550 4008431245508
- S 24556 4008431245560

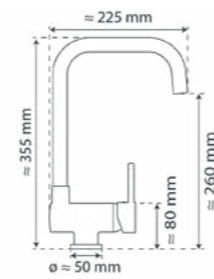
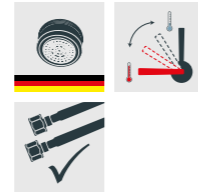

LUCA

- MB35210 4014456352107



ULTRA

- 94800 4008431948003

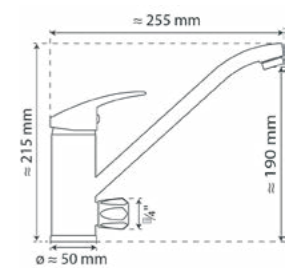

Küchenarmatur mit Geräteanschluss für den komfortablen Anschluss des Geschirrspülers oder der Waschmaschine

EN | Kitchen tap with appliance connection for a convenient connection of the dishwasher or washing machine

FR | Mitigeur cuisine avec raccordement machine pour un branchement confortable du lave-vaisselle ou de la machine à laver

NL | Keukenkraan met machineaansluiting voor een gemakkelijke aansluiting van de vaatwasser of wasmachine



MIAMI

- 79142 4008431791425
- 79146U 4008431791463

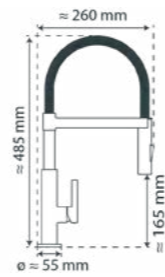

MIAMI

- 79140U 4008431094717
- 79147 4008431791470

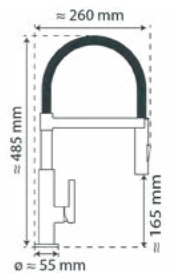

GLASGOW

- 79586 4008431795867

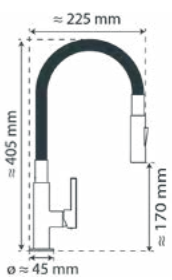
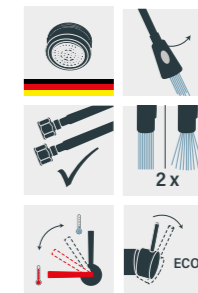

incl.



STILO

- 79180 4008431791807

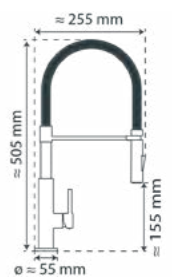
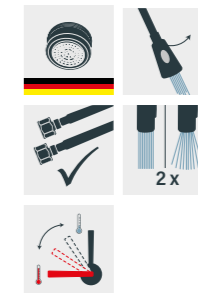

incl.



DESIGN

- 23138 4014456231389

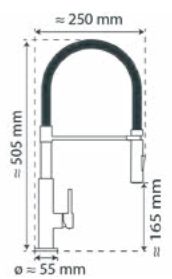
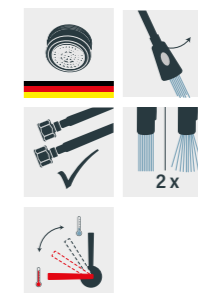

NEW YORK

- 79170 4008431791708

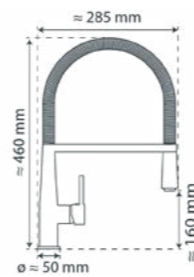
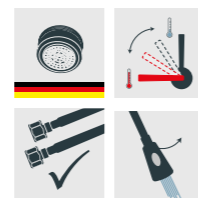

CORNWALL

- 79150U 4008431094632
- 79155U 4008431094649

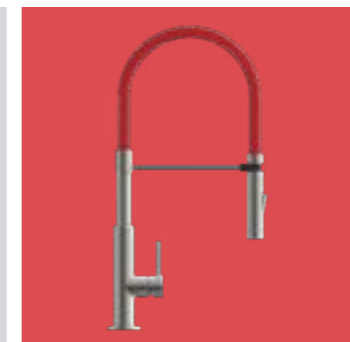
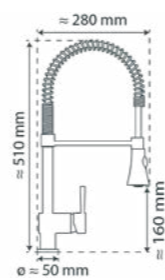



BLACKPOOL

- 79516 4008431795164
- 79526 4008431795263
- 79562 4008431795621
- S 79566 4008431795669

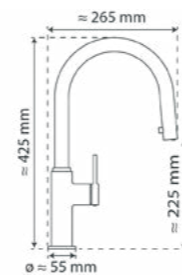
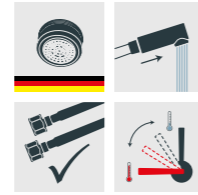

LONDON

- 79700U 4008431094762
- 79705 4008431797052
- 79720U 4008431094793
- S 79760 4008431797601
- L 79770 4008431797700

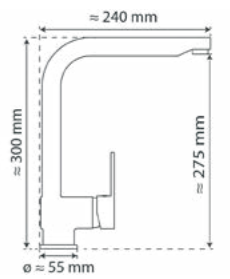
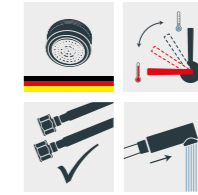



UNICORN

- 33770 4008431337708
- 33777 4008431337777

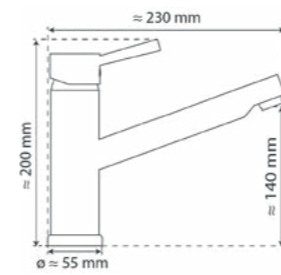
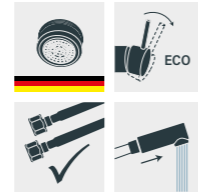

DIZIANI

- 35670 4008431356709
- S 35676 4008431356761

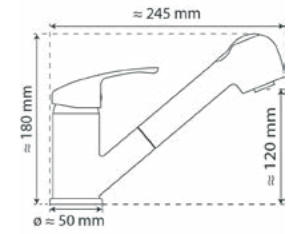
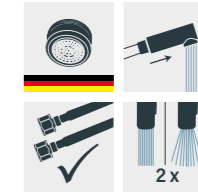

SUPRA

- 97700 4008431977003

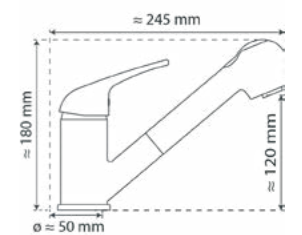
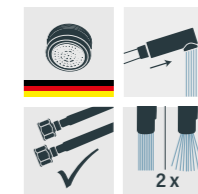



CORNWALL

- 79116U 4008431094564
- 79126U 4008431094588
- W 79161U 4008431094656
- 79162U 4008431094663
- A 79164 4008431791647
- S 79166U 4008431094687
- 79167 4008431092249

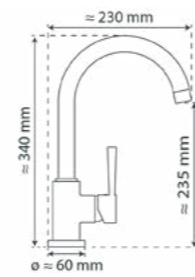

MANETTI

- 35816 4008431358161

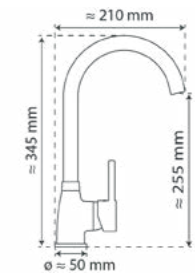
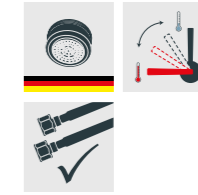

ATTICA

- 22550 4008431225500

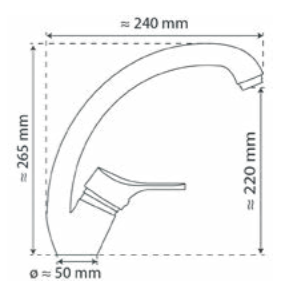

DIZIANI

- 35755 4008431357553

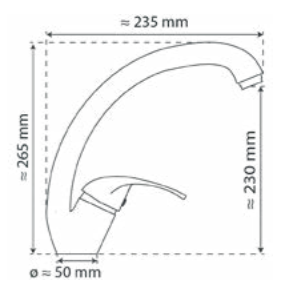



BRISTOL

● 74125 4008431741253

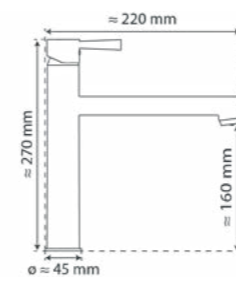

RIO

- 79816U 4008431094847
- 79826U 4008431094854
- S 79860U 4008431096285
- S 79866U 4008431094861

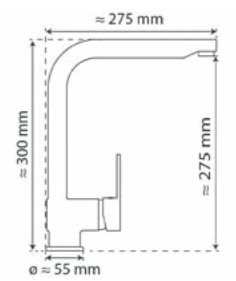
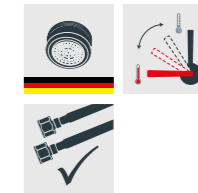

Langlebig und robust durch massiven Edelstahl

EN | Durable and robust due to solid stainless steel
 FR | Durable et robuste grâce à l'acier inoxydable massif
 NL | Duurzaam en robuust dankzij massief roestvrij staal



> 79866



OLD STYLE

● 72500 4008431725000

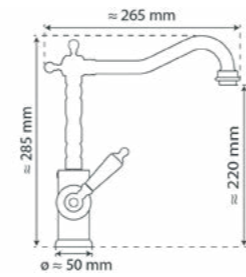

GRANDE

● 77250 4008431772509
 ● S 77266 4008431772660

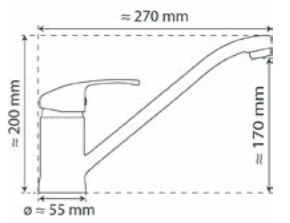

YORK

● 79616 4008431796161
 ● S 79666U 4008431094755

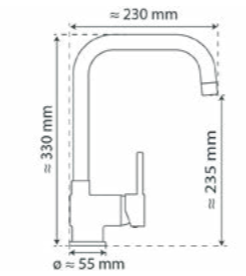

CORNWALL

● 79115 4008431791159
 ● 79125 4008431791258

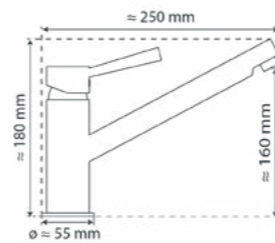

CELLINO

● 35450 4008431354507

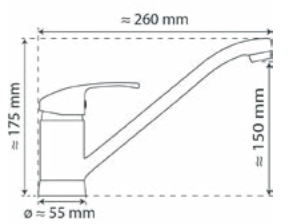

VITAL

● 24250 4008431242507

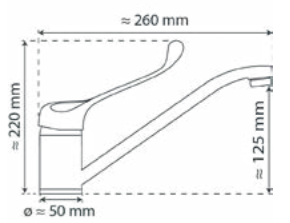



FALCON

● 33250 4008431332505

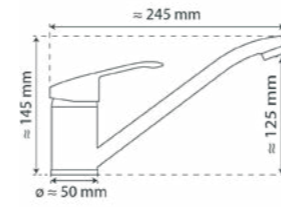

MAGNA

● 77150 4008431771502

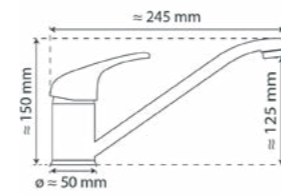

DANTE

● 35550 4008431355504

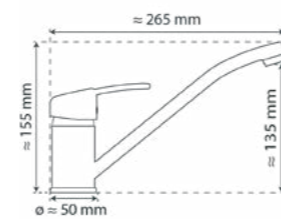

PORTO

● 77450 4008431774503

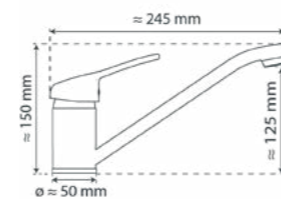

SIGNO

● 77085 4008431770857

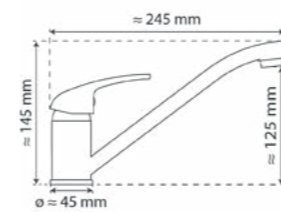

BIRTE

● 75208 4014456752082

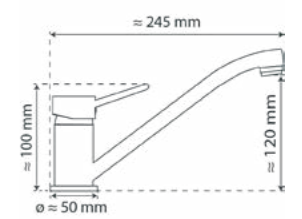

ATHOS

● 77050 4008431770505

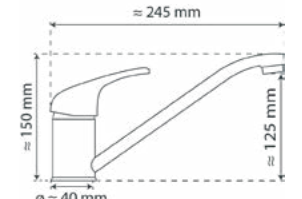

ATHOS PLUS

● 41500 4008431415000

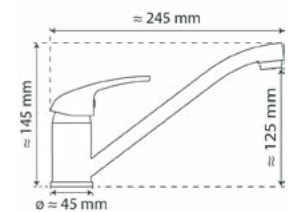



BRILLANT

● 57500 4008431575001

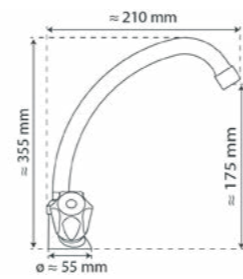

ATTICA

● 22600 4008431226002

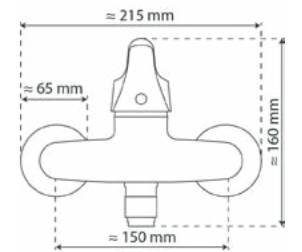

ORAZI

● 36760 4008431367606

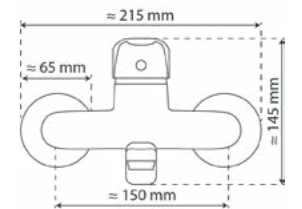

BRILLANT

● 57600 4008431576008

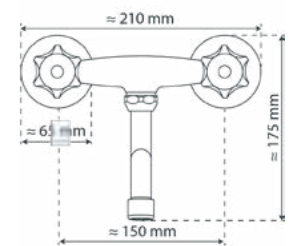

CESTI

● 37150 4008431371504

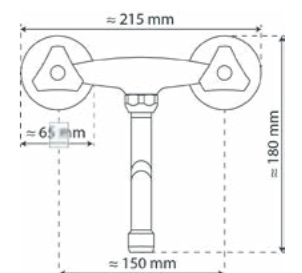

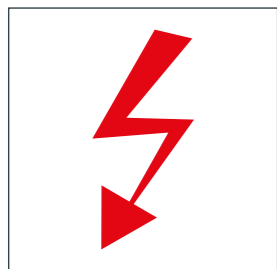

Niederdruck-Armaturen sind speziell für den Einsatz an drucklosen Warmwasserspeichern konzipiert und regulieren den Wasserfluss in Systemen mit geringem Druck. Sie schützen den Speicher vor Überdruck und sorgen für eine sichere, zuverlässige Warmwasserversorgung in Küche und Bad. Diese Armaturen sind unerlässlich, wenn es keinen direkten Anschluss an eine Warmwasserleitung gibt.

EN | Low-pressure taps are specially designed for use on unpressurised hot water storage tanks and regulate the water flow in systems with low pressure. They protect the cylinder from overpressure and ensure a safe, reliable hot water supply in the kitchen and bathroom. These taps are essential if there is no direct connection to a hot water pipe.

FR | Les mitigeurs basse pression sont spécialement conçus pour être utilisés sur les ballons d'eau chaude sans pression et régulent le débit d'eau dans les systèmes à faible pression. Ils protègent le ballon de la surpression et assurent une alimentation en eau chaude sûre et fiable dans la cuisine et la salle de bains. Ces mitigeurs sont indispensables lorsqu'il n'y a pas de raccordement direct à une conduite d'eau chaude.

NL | Lagedrukkranen zijn speciaal ontworpen voor gebruik op opslagtanks voor warm water zonder druk en regelen de watertoevoer in systemen met lage druk. Ze beschermen de boiler tegen overdruk en zorgen voor een veilige, betrouwbare warmwatervoorziening in de keuken en badkamer. Deze kranen zijn onmisbaar als er geen directe aansluiting op een warmwaterleiding is.



> 79719
Seite 48



CORNWALL

- 79190 4008431791906
- 79195U 4008431094731

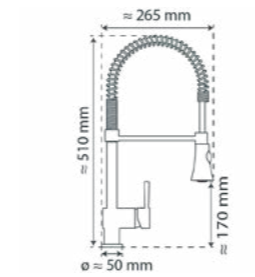
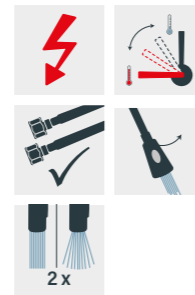

CORNWALL

- 79119U 4008431094571
- 79129U 4008431094595
- S 79169U 4008431094700

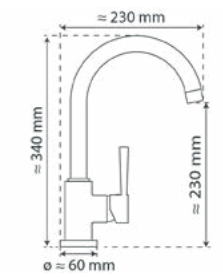
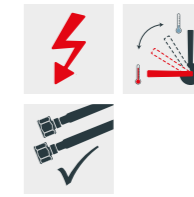

LONDON

- 79719U 4008431094786
- 79729U 4008431094809
- S 79769 4008431797694

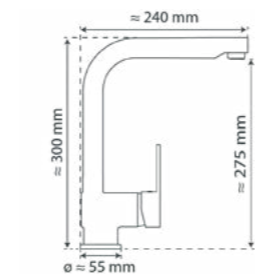
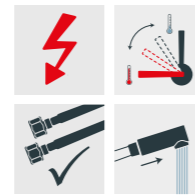

CASALLA

- 35319 4008431353197

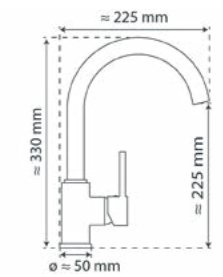
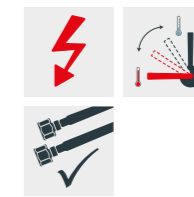

RIO

- 79819 4008431096308
- S 79869 4008431096292

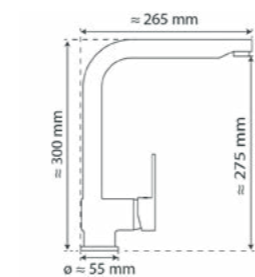
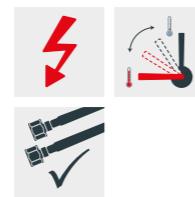

DIZIANI

- 35679 4008431356792

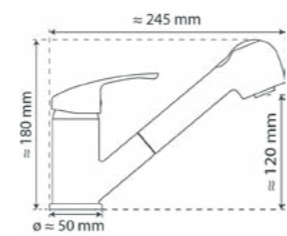
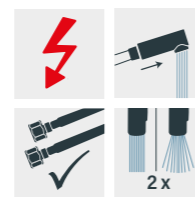

ULTRA

- 94710 4008431947105

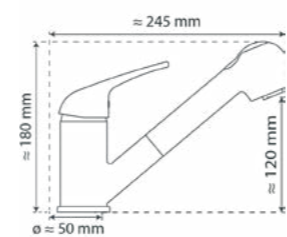
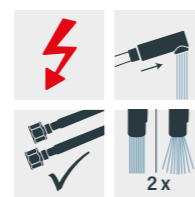



FALCON

● 33290 4008431332901

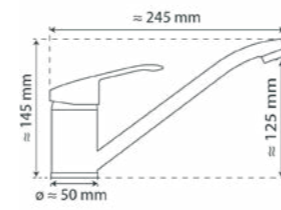

CELLINO

● 35490 4008431354903

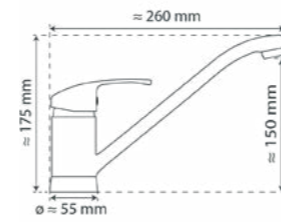

ULTRA

● 94900 4008431949000

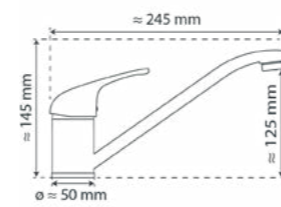

TASSONI

● 35590 4008431355900
● S 35596 4008431355962

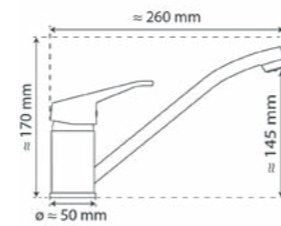

PERUZZI

● 37390 4008431373904

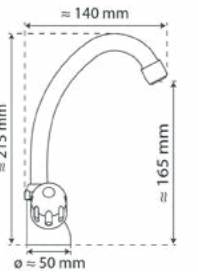

● 37690 4008431376905

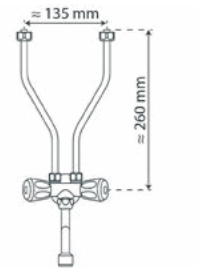

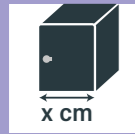

Für x cm Schrankbreite

EN | For x cm cabinet width
FR | Pour une largeur d'armoire de x cm
NL | Voor x cm kastbreedte

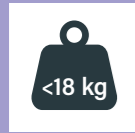

Maximale Belastbarkeit: 18 kg

EN | Maximum load capacity: 18 kg
FR | Capacité de charge maximale : 18 kg
NL | Maximaal draagvermogen: 18 kg



Inkl. flexibler Anschlusschläuche

EN | Incl. flexible connection hoses
FR | Flexibles de raccordement inclus
NL | Incl. flexibele aansluitslangen

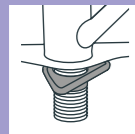

Spülenverstärkung für Armaturen

EN | Sink reinforcement for taps
FR | Renfort d'évier pour robinetterie
NL | Wastafelversteving voor kranen



Herdanschlusskabel, 200 cm

EN | Cooker connection cable, 200 cm
FR | Câble de raccordement à la cuisinière, 200 cm
NL | Aansluitkabel fornuis, 200 cm

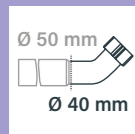

Siphon mit 40/50 mm Abgang

EN | Siphon with 40/50 mm outlet
FR | Siphon avec sortie de 40/50 mm
NL | Sifon met afvoer van 40/50 mm

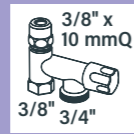

Gerätezusatzventil

EN | Additional device valve
FR | Robinet de raccordement d'appareil
NL | Kraan met apparaat aansluiting

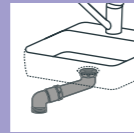

Raumschafferbogen

EN | Space-saving waste bend
FR | Coude d'évacuation gain de place
NL | Ruimtebesparende afvoerbocht

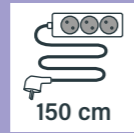

3-fach Steckdose, 150 cm Kabel

EN | 3-fold socket, 150 cm cable
FR | Prise de courant triple, 150 cm de câble
NL | 3-voudig stopcontact, 150 cm kabel



HT safe Bogen/Rohr (DN 50)

EN | HT safe bend/tube (DN 50)
FR | HT safe coude/tube (DN 50)
NL | HT safe bocht/buis (DN 50)



Aluminium Klebeband, 500 cm

EN | Aluminium adhesive tape, 500 cm
FR | Ruban adhésif en aluminium, 500 cm
NL | Aluminium tape, 500 cm



Schlauchklemmen

EN | Hose clamps
FR | Colliers de flexible
NL | Slangklemmen

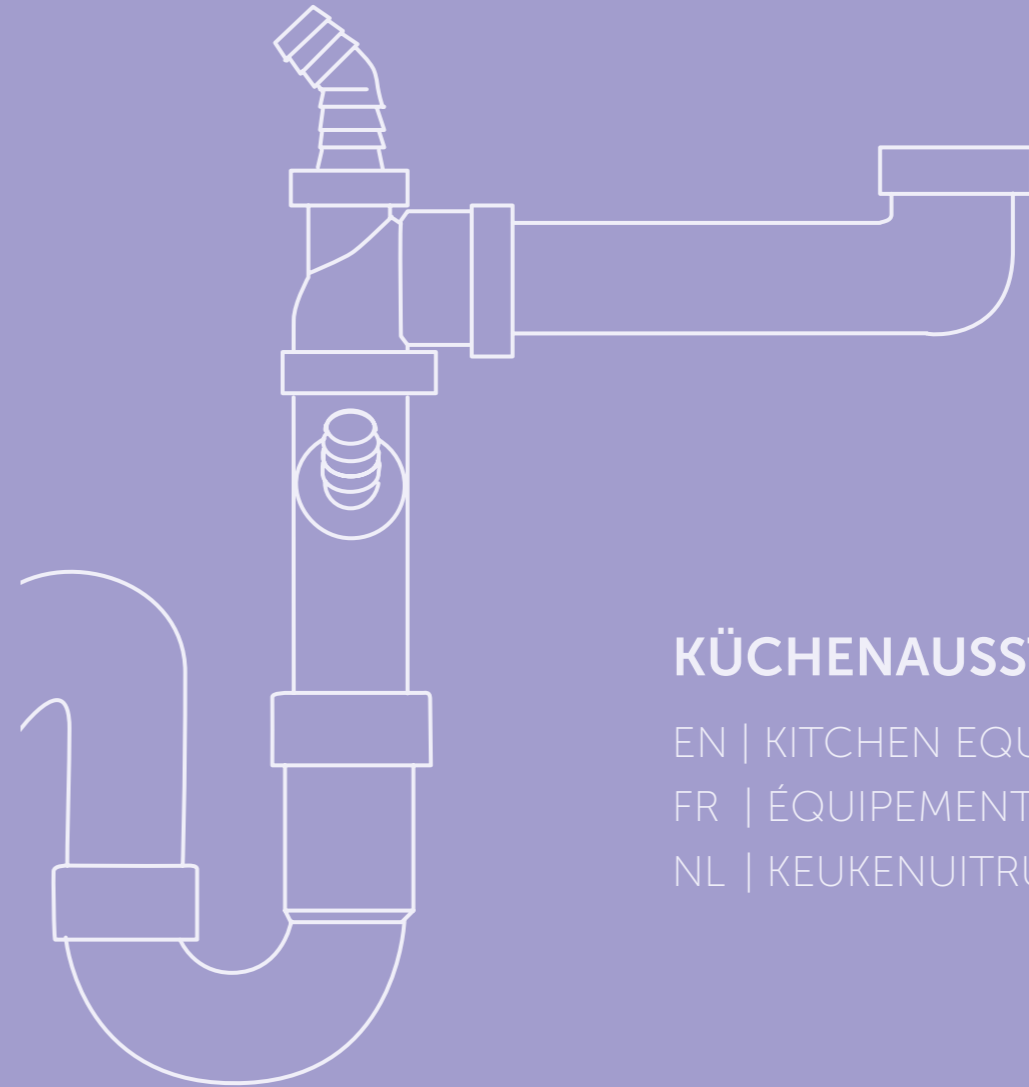

KÜCHENAUSSTATTUNG

EN | KITCHEN EQUIPMENT
FR | ÉQUIPEMENT DE CUISINE
NL | KEUKENUITRUSTING



MONTAGE-SET | MOUNTING KIT | KIT DE MONTAGE | MONTAGEKIT

104 4014456001043

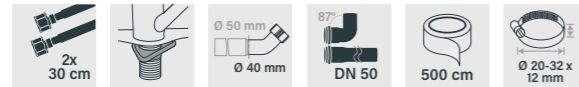

MONTAGE-SET | MOUNTING KIT | KIT DE MONTAGE | MONTAGEKIT

12000 4053452018969

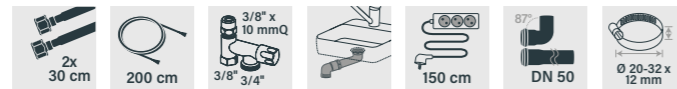

SPÜLTISCH SIPHON | SINK TRAP | SIPHON D'ÉVIER | SPOELBAK SIFON

01243 4008431012438



SPÜLTISCH SIPHON | SINK TRAP | SIPHON D'ÉVIER | SPOELBAK SIFON

98801048 4007111801041



ANSCHLUSS-SET | CONNECTION SET | SET DE RACCORDEMENT | AANSLUITSET

111 4014456001111



ANSCHLUSS-SET | CONNECTION SET | SET DE RACCORDEMENT | AANSLUITSET

116 4014456001166

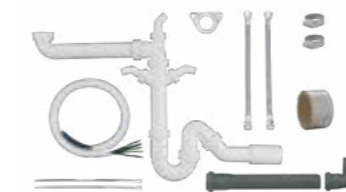
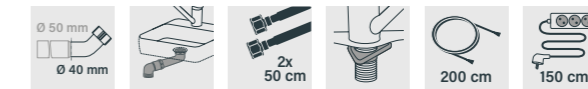

ANSCHLUSS-SET | CONNECTION SET | SET DE RACCORDEMENT | AANSLUITSET

119 4014456999340





HERDANSCHLUSSKABEL | STOVE CONNECTION CABLE | CÂBLE DE RACCORDEMENT DE LA CUISINIÈRE | AANSLUITKABEL FORNUIS

1275	4014456012759	2 m, H05 V V-F, 5 x 2,5 mm
1276	4014456012766	5 m, 5 x 2,5 mm, 100/80 mm AEH / AEH



MONTAGESCHIENEN | MOUNTING RAILS | RAILS DE MONTAGE | MONTAGERAILS

2019	4014456020198
------	---------------



KÜCHENANSCHLUSSBOX | KITCHEN JUNCTION BOX | BOÎTIER DE RACCORDEMENT POUR CUISINE | KEUKEN-AANSLUITDOOS

2200	4014456022000
------	---------------

L1 L2 L3 N PE



Netz (Herdanschlussdose)
Mains (stove junction box)
Réseau (boîte de raccordement de la cuisinière)
Lichtnet (aansluitdoos fornuis)
H05VV-F 5G 2,5 mm²

Anschlussbox
Junction box
Boîtier de raccordement
Aansluitdoos

Kochfeld
Hob
Table de cuisson
Kookplaat
H05VV-F 4G 2,5 mm²

Backofen/Geschirrspüler
Oven/dishwasher
Four/lave-vaisselle
Oven/vaatwasser
H05VV-F 3G 1,5 mm²





Marken-Mischdüse für ein perfektes Strahlbild

EN | Brand name aerator for a perfect spray pattern
FR | Aérateur de marque pour un jet parfait
NL | Merk straalregelaar voor een perfect straalbeeld



Inkl. flexibler Anschlussschläuche

EN | Incl. flexible connection hoses
FR | Flexibles de raccordement inclus
NL | Incl. flexibele aansluitslangen



Wassersparende Eco-Click-Funktion

EN | Water-saving eco-click function
FR | Fonction éco-clic économisant l'eau
NL | Waterbesparende eco-klik functie

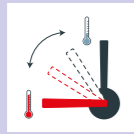

Praktische Cold-Start-Funktion

EN | Practical cold-start function
FR | Fonction pratique de démarrage à eau froide
NL | Praktische cold-start functie



1 1/4" (Ø ca. 4 cm) Ablaufgarnitur

EN | 1 1/4" (Ø approx. 4 cm) pop-up waste
FR | Bonde de lavabo 1 1/4" (Ø env. 4 cm)
NL | 1 1/4" (Ø ca. 4 cm) pop-up waste



1 1/4" (Ø ca. 4 cm) Ablaufgarnitur Push-Open

EN | 1 1/4" (Ø approx. 4 cm) push pop-up waste
FR | Bonde de lavabo clic-clac 1 1/4" (Ø env. 4 cm)
NL | 1 1/4" (Ø ca. 4 cm) push pop-up waste



1/2" (Ø ca. 1,9 cm) Brauseschlauchanschluss

EN | 1/2" (Ø approx. 1,9 cm) shower hose connection
FR | Raccord du flexible de douche 1/2" (Ø env. 1,9 cm)
NL | 1/2" (Ø ca. 1,9 cm) verbinding voor doucheslang



Ausladung der Armatur ca. x mm

EN | Saliency approx. x mm
FR | Saillie env. x mm
NL | Uitsteeksel ca. x mm



Inklusive Brausegarnitur

EN | Including shower set
FR | Garniture de douche incluse
NL | Inclusief doucheset



Besonders langlebige Verchromung — gemäß DIN EN 248 Besonders leise — Geräuschklasse A Zuverlässige Keramik Kartusche — Dauerprüfung gemäß DIN EN 817

EN | Particularly durable chrome plating — according to DIN EN 248
Particularly quiet — noise class A
Reliable ceramic cartridge — endurance test according to DIN EN 817
FR | Chromage particulièrement durable — selon DIN EN 248
Particulièrement silencieux — classe sonore A
Cartouche céramique fiable — test d'endurance selon DIN EN 817
NL | Bijzonder duurzaam verchroomd — volgens DIN EN 248
Bijzonder stil — geluidsklasse A
Betrouwbare keramische cartridge — duurzaamheidstest volgens DIN EN 817

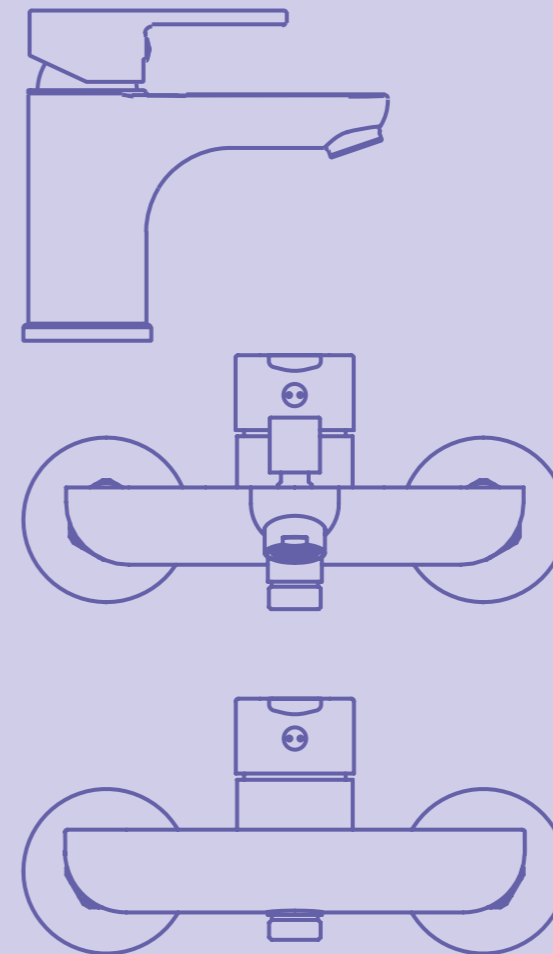

BADARMATUREN-SERIEN

EN | BATHROOM TAP SERIES

FR | SÉRIES DE MITIGEURS DE SALLE DE BAINS

NL | BADKAMERKRAAN SERIES



> 33116
Seite 63



LOS ANGELES

- 33100 4008431331003
- 33106 4008431331065

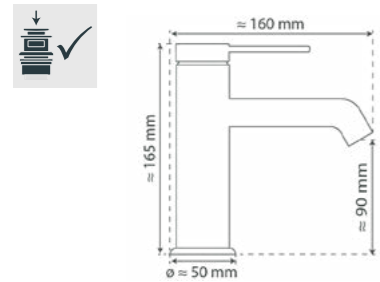

- 33190 4008431331904
- 33196 4008431331966

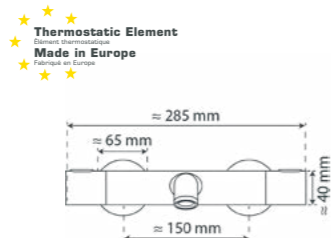

- 33180 4008431331805
- 33186 4008431331867

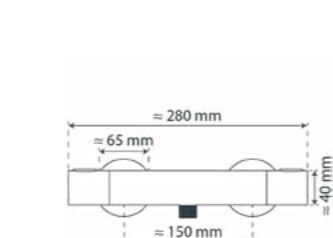

- 33110 4008431092652
- 33116 4008431331164

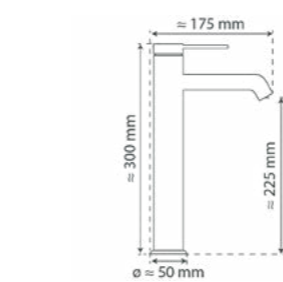

- 33120 4008431331201
- 33126 4008431331263

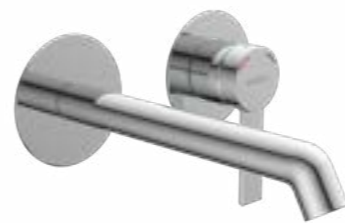
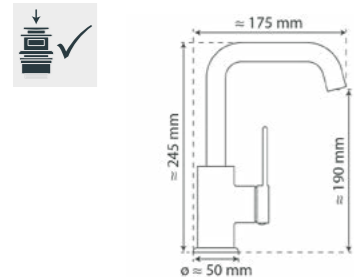

- 33160 4008431331607
- 33166 4008431331669

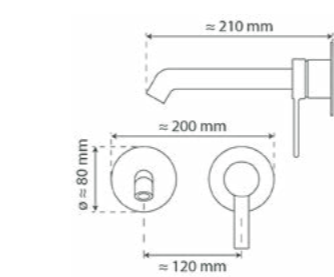



DENVER
 S 44106 4008431441061

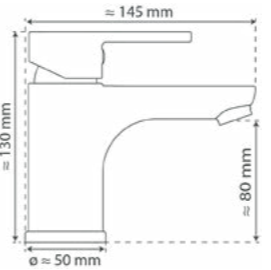

S 44306 4008431443065

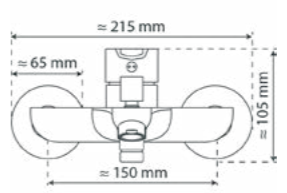

S 44406 4008431444062

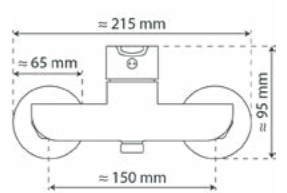

FUTURA
 S 18010 DVGW 4008431180106

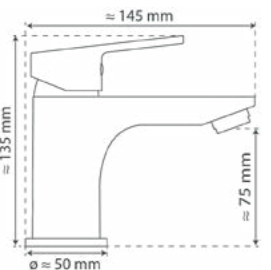

S 18030 DVGW 4008431180304

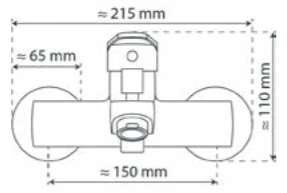
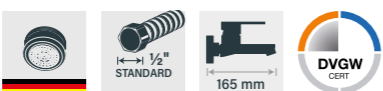

S 18040 DVGW 4008431180403

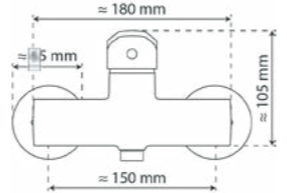



PICO

● 13210 4008431132105

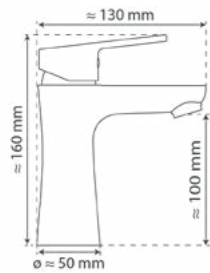

● 13213 4008431132136

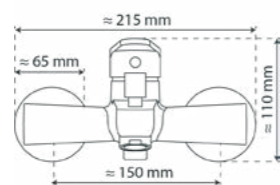

● 13214 4008431132143

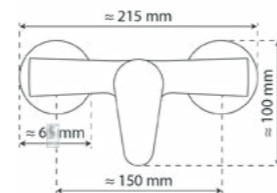

TOKYO II

● 24110 4008431241104

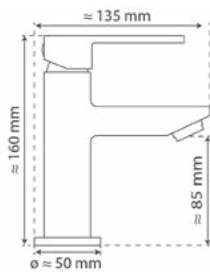

● 24130 4008431241302

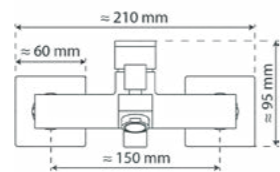

● 24140 4008431241401

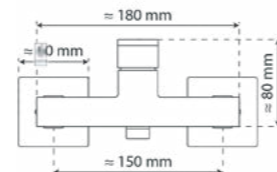

CALVINO

● 35210 4008431352107

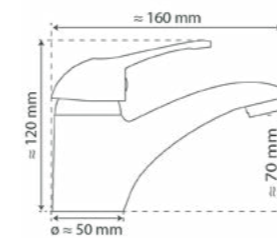

● 35230 4008431352305

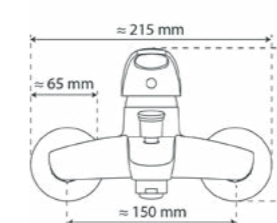
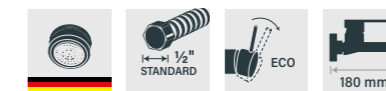

● 35240 4008431352404

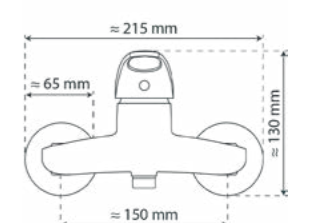



LAURANA

● 35910 4008431359106

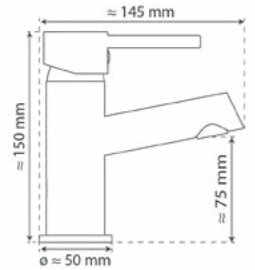

● 35930 4008431359304

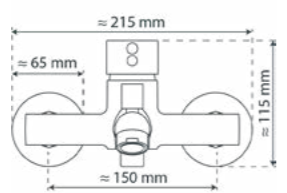

● 35940 4008431359403

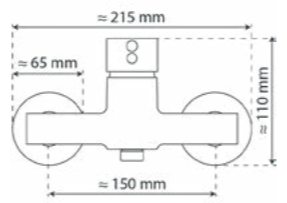

BATONI

● 35010 4008431350103

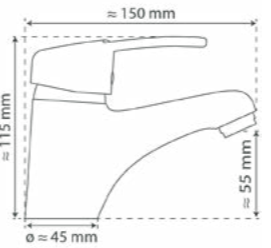

● 35030 4008431350301

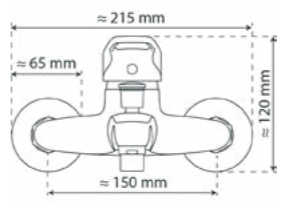

● 35040 4008431350400

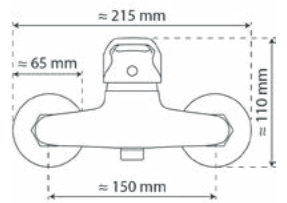

TESSA

● 36510 4008431365107

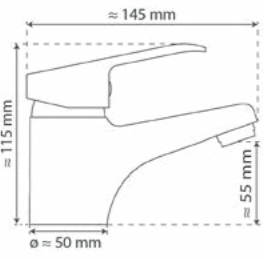

● 36530 4008431365305

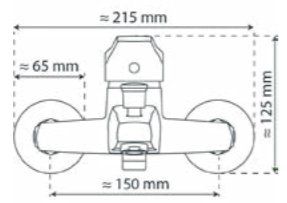

● 36540 4008431365404

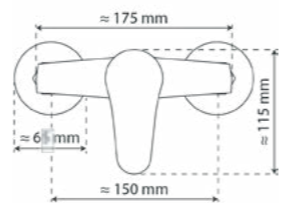

PORTO

● 77410 4008431774107

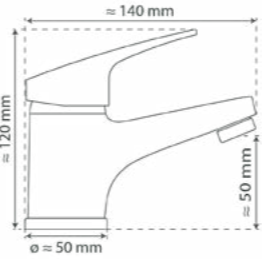

● 77430 4008431774305

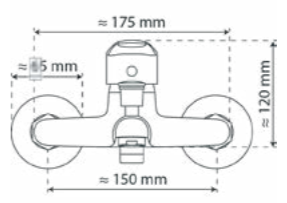

● 77440 4008431774404

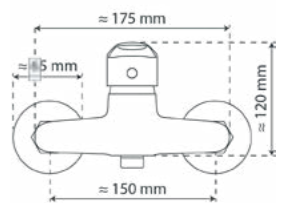



SIRANI

● 36410 4008431364100

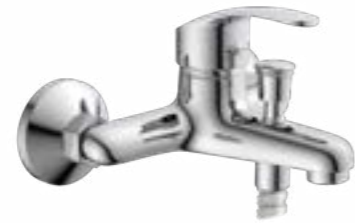
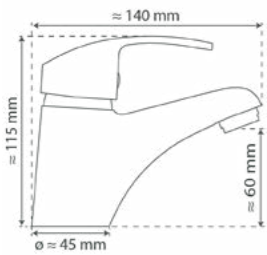

● 36430 4008431364308

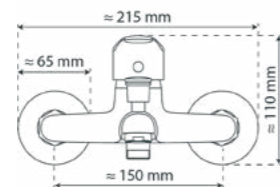

● 36440 4008431364407

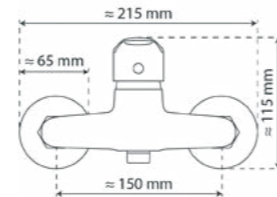

ATHOS PLUS

● 41100 4008431411002

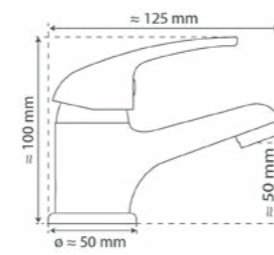

● 41300 4008431413006

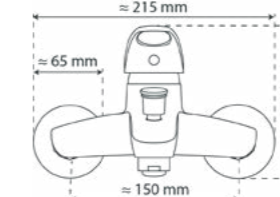

● 41400 4008431414003

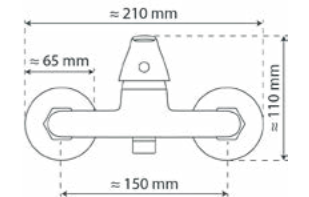

VICO

● 42100 4008431421001

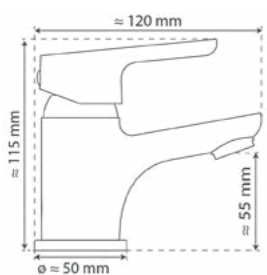

● 42300 4008431423005

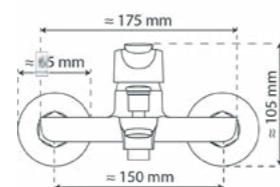

● 42400 4008431424002

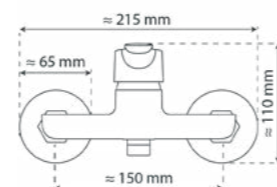

ATHOS PLUS

● 41200 4008431412009

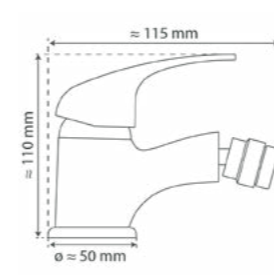



ELK

● 33510 4008431335100

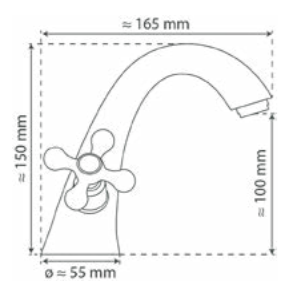

● 33530 4008431335308

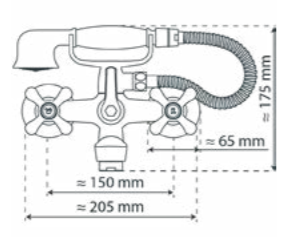
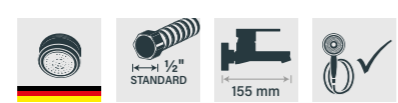

SAVINO

● 37210 4008431372105

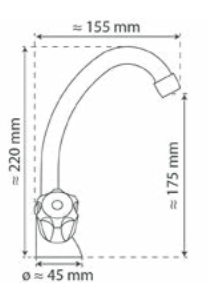

● 37240 4008431372402

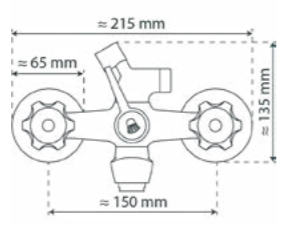
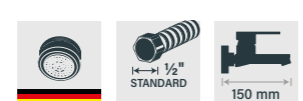

● 37230 4008431372303

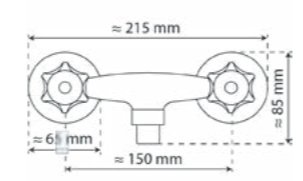



Marken-Mischdüse für ein perfektes Strahlbild

EN | Brand name aerator for a perfect spray pattern
FR | Aérateur de marque pour un jet parfait
NL | Merk straalregelaar voor een perfect straalbeeld



Berührungslose Infrarottechnologie

EN | Non-contact infrared technology
FR | Technologie infrarouge sans contact
NL | Contactloze infraroodtechnologie



Inkl. flexibler Anschlusschläuche

EN | Incl. flexible connection hoses
FR | Flexibles de raccordement inclus
NL | Incl. flexibele aansluitlangen



Inkl. 1 1/4" (Ø ca. 4 cm) Ablaufgarnitur

EN | Incl. 1 1/4" (Ø approx. 4 cm) pop-up waste
FR | Bonde de lavabo 1 1/4" (Ø env. 4 cm) inclus
NL | Incl. 1 1/4" (Ø ca. 4 cm) pop-up waste



Wassersparende Eco-Click-Funktion

EN | Water-saving eco-click function
FR | Fonction éco-clic économisant l'eau
NL | Waterbesparende eco-klik functie



Inkl. 1 1/4" (Ø ca. 4 cm) Ablaufgarnitur Push-Open

EN | Incl. 1 1/4" (Ø approx. 4 cm) push pop-up waste
FR | Bonde de lavabo clic-clac 1 1/4" (Ø env. 4 cm) inclus
NL | Incl. 1 1/4" (Ø ca. 4 cm) push pop-up waste

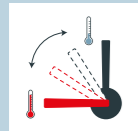

Praktische Cold-Start-Funktion

EN | Practical cold-start function
FR | Fonction pratique de démarrage à eau froide
NL | Praktische cold-start functie

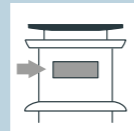

Geeignet für Waschbecken mit Überlauffunktion

EN | Suitable for washbasins with overflow function
FR | Convient aux lavabos avec fonction trop-plein
NL | Geschikt voor wastafels met overloopfunctie

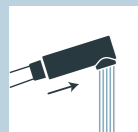

Mit herausziehbarem Auslauf

EN | With pull-out spout
FR | Avec bec extractible
NL | Met uittrekbare uitloop

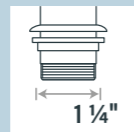

1 1/4" (Ø ca. 4 cm) Gewinde

EN | 1 1/4" (Ø approx. 4 cm) thread
FR | Filetage de 1 1/4" (Ø env. 4 cm)
NL | 1 1/4" (Ø ca. 4 cm) schroefdraad



Nur geeignet für den Kaltwasseranschluss

EN | Only suitable for cold-water connection
FR | Convient uniquement pour le raccordement à l'eau froide
NL | Alleen geschikt voor koudwateraansluiting



Ablaufgarnitur Push-Open

EN | Push pop-up waste
FR | Bonde de lavabo clic-clac
NL | Push pop-up waste



Automatischer Wasserstopp nach 10 Sekunden

EN | Automatic water stop after 10 seconds
FR | Arrêt automatique de l'eau après 10 secondes
NL | Automatische waterstop na 10 seconden



Breite der Abdeckung Ø x mm

EN | Cover width Ø x mm
FR | Largeur du couvercle Ø x mm
NL | Dekselbreedte Ø x mm



WASCHTISCHARMATUREN

EN | WASHBASIN MIXERS

FR | MITIGEURS DE LAVABO

NL | WASTAFELKRANEN



› 33010
Seite 81



NIAGARA

● 26110 4008431261102

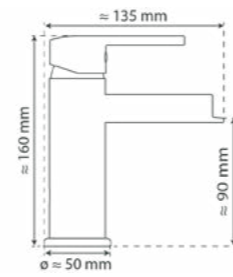

PANAMA

● 98100 4008431981000
 ● S 98106 4008431981062

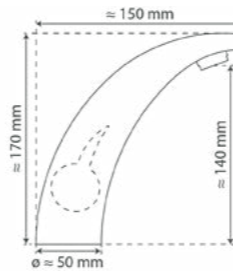

CORNWALL

● 79111 4008431791111

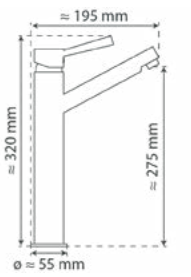

CORNWALL

● 79011 4008431790114

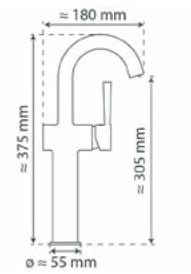
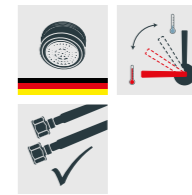



LONDON

● 79710 4008431797106

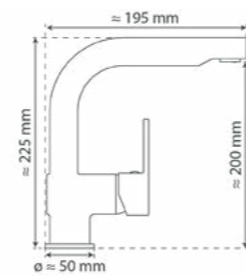

NEW YORK

● 33610 4008431336107
 ● 33612 4008431336121
 ● S 33616 4008431336169
 ● 33617 4008431336176

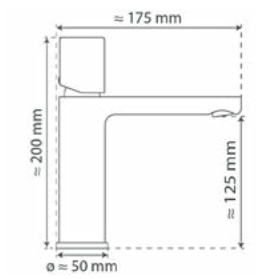

ATTICA

● 22150 4008431221502

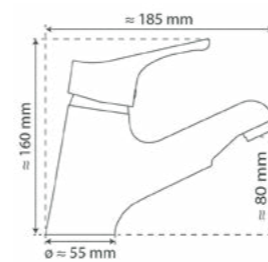
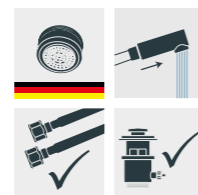

MANHATTAN

● 33010 4008431330105
 ● S 33016 4008431330167
 ● W 33018 4008431330181

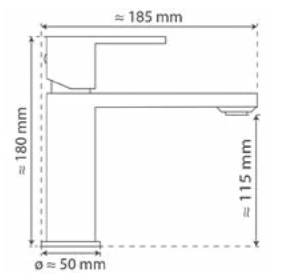

CORNWALL

● 20150 4008431201504

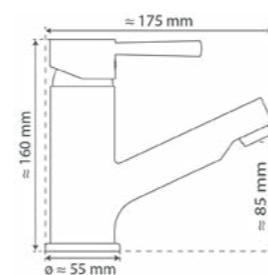
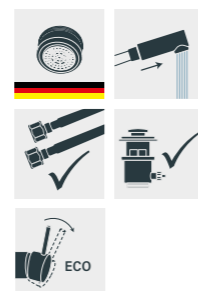

RAVEN

● 34010 4008431340104
 ● S 34016 4008431340166

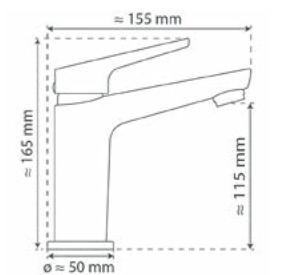
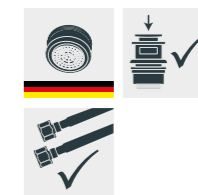



ELEPHANT

● 34210 4008431342108

● 34212 4008431342122

● 34213 4008431342139

● 34216 4008431342160

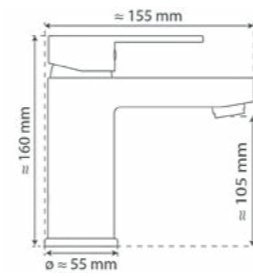
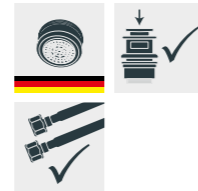

CORNWALL

● 79010 4008431790107

● 79016 4008431790169

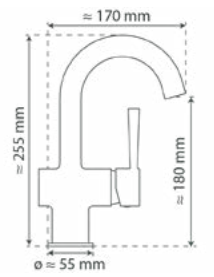
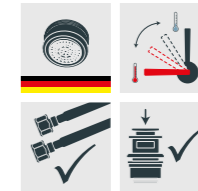
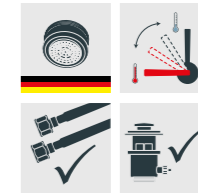

GLASGOW

● 32586 4008431325866

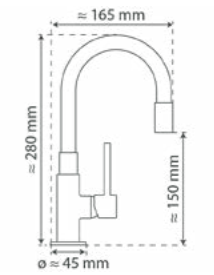
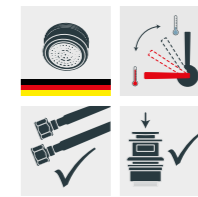



BOSTON

- 33210 4008431332109
- 33212 4008431332123
- S 33216 4008431332161

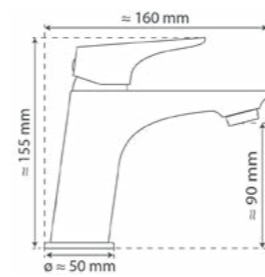

LIVERPOOL

- 33410 4008431334103

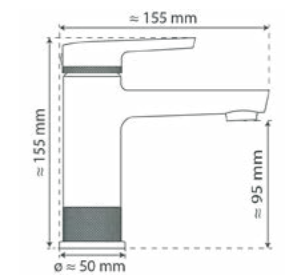

SAN DIEGO

- S 32516 4008431325163

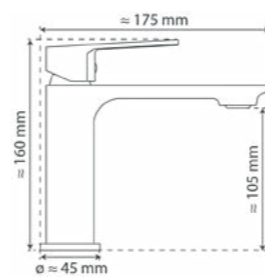
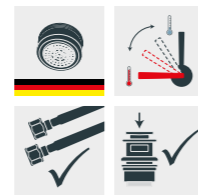

MONTANA

- 32310 4008431093758
- S 32316 4008431323169

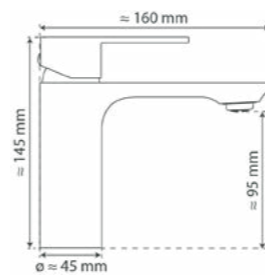
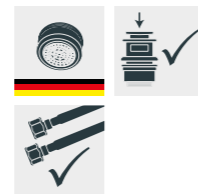

ARIZONA

- 32410 4008431324104
- S 32416 4008431324166

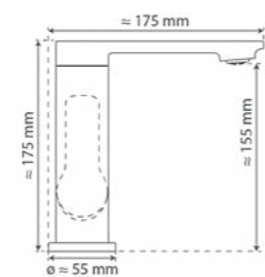
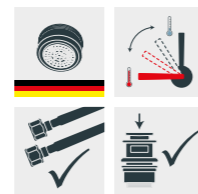

MADAGASKAR

- S 43106 4008431431062

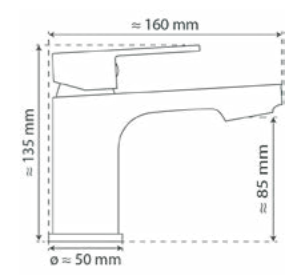

ALASKA

- W 34710 4008431347103

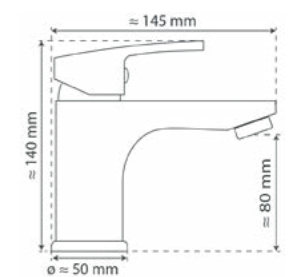



UNICORN

● 33710 4008431337104

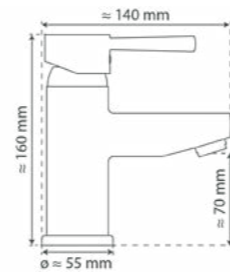

MAGNA

● 77110 4008431771106

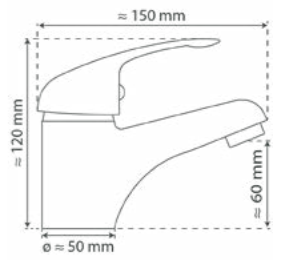

ATLANTA

● 79910 4008431799100

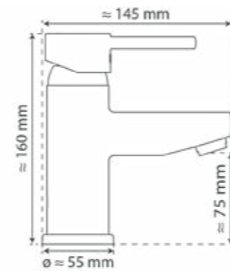

ATHOS

● 77010 4008431770109

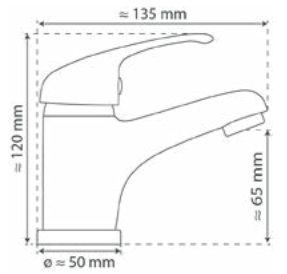

CORNWALL

● 79110 4008431791104

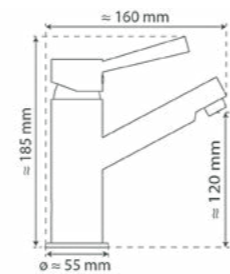

CARNEO

● 37110 4008431371108

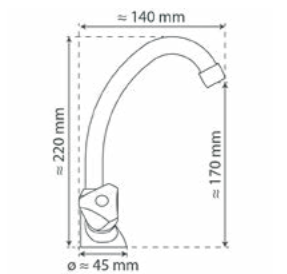

DERBY

● 32210 4008431322100

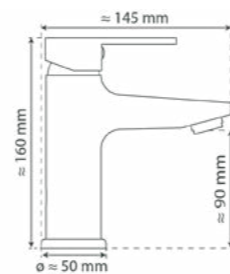
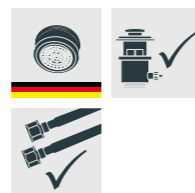

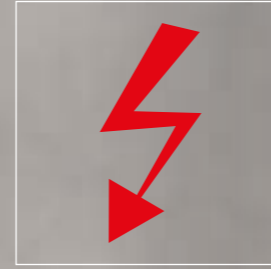

Niederdruck-Armaturen sind speziell für den Einsatz an drucklosen Warmwasserspeichern konzipiert und regulieren den Wasserfluss in Systemen mit geringem Druck. Sie schützen den Speicher vor Überdruck und sorgen für eine sichere, zuverlässige Warmwasserversorgung in Küche und Bad. Diese Armaturen sind unerlässlich, wenn es keinen direkten Anschluss an eine Warmwasserleitung gibt.

EN | Low-pressure taps are specially designed for use on unpressurised hot water storage tanks and regulate the water flow in systems with low pressure. They protect the cylinder from overpressure and ensure a safe, reliable hot water supply in the kitchen and bathroom. These taps are essential if there is no direct connection to a hot water pipe.

FR | Les mitigeurs basse pression sont spécialement conçus pour être utilisés sur les ballons d'eau chaude sans pression et régulent le débit d'eau dans les systèmes à faible pression. Ils protègent le ballon de la surpression et assurent une alimentation en eau chaude sûre et fiable dans la cuisine et la salle de bains. Ces mitigeurs sont indispensables lorsqu'il n'y a pas de raccordement direct à une conduite d'eau chaude.

NL | Lagedrukkranen zijn speciaal ontworpen voor gebruik op opslagtanks voor warm water zonder druk en regelen de watertoevoer in systemen met lage druk. Ze beschermen de boiler tegen overdruk en zorgen voor een veilige, betrouwbare warmwatervoorziening in de keuken en badkamer. Deze kranen zijn onmisbaar als er geen directe aansluiting op een warmwaterleiding is.



› 77115
Seite 90



CORNWALL

● 79101 4008431791012

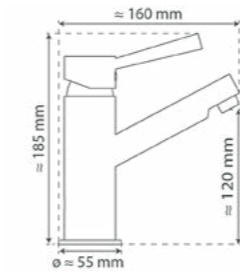
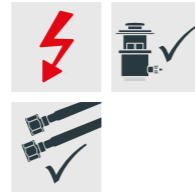

MAGNA

● 77115 4008431771151

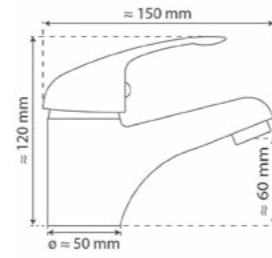
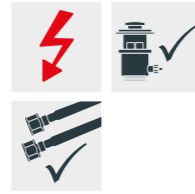

ORAZI

● 36619 4008431366197

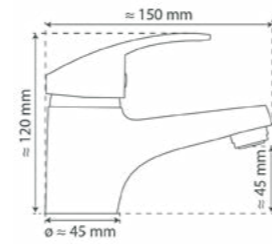
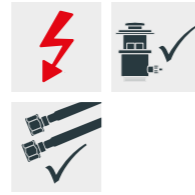

BRILLANT

● 57110 4008431571102

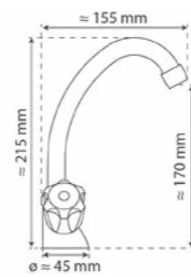
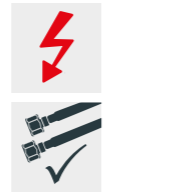



› 37965
Seite 95

Der Kaltwasserhahn ist die ideale Armatur, überall dort wo kein Warmwasser benötigt wird. Das spart Geld und Energie. Ein kleiner Beitrag für die Umwelt.

EN | The cold-water tap is the ideal choice wherever hot water is not required. This saves money and energy. A small contribution to the environment.

FR | Le robinet d'eau froide est le choix idéal, partout où l'on n'a pas besoin d'eau chaude. Cela permet d'économiser de l'argent et de l'énergie. Une petite contribution pour l'environnement.

NL | De fonteinkraan is de ideale kraan als er geen warm water nodig is. Dit bespaart geld en energie. Een kleine bijdrage voor het milieu.



VITAL

● 99100 4008431991009

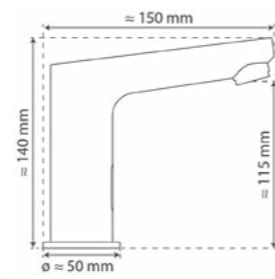
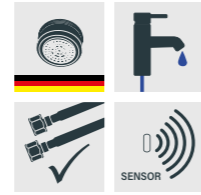

ARAGON

● 37955 4008431379555
 ● S 37965 4008431379654

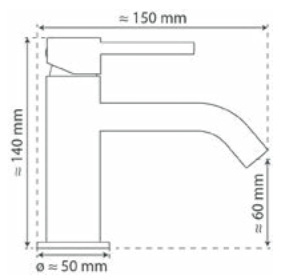

LAURANA

● 35911 4008431359113

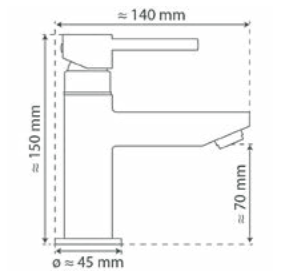

LIMA

● 46951 4008431090801

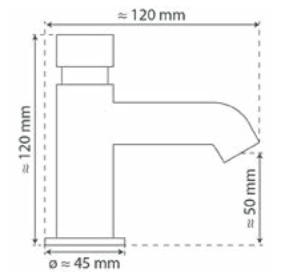

Nach Betätigung schließt die Armatur automatisch nach 10 Sekunden

EN | The valve shuts off automatically 10 seconds after activation

FR | La vanne se ferme automatiquement au bout de 10 secondes après son ouverture

NL | Na het bedienen sluit de kraan automatisch na 10 seconden



MATAO

● 37956 4008431379562

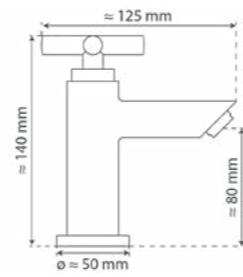

CARNEO

● 37950 4008431379500

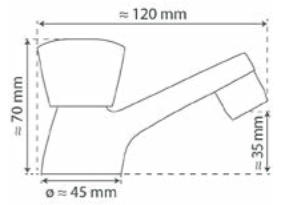

VICO

● 37958 4008431379586

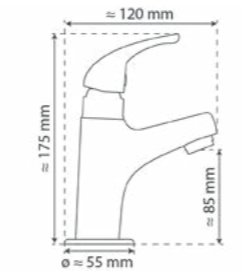

CARNEO

● 37970 4008431379708

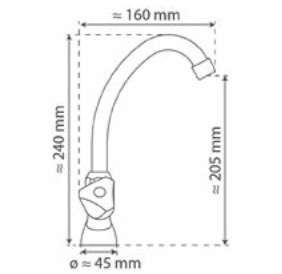

CARNEO

● 37980 4008431379807

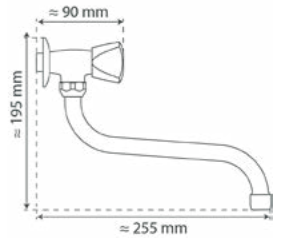

CARNEO

● 37985 4008431379852

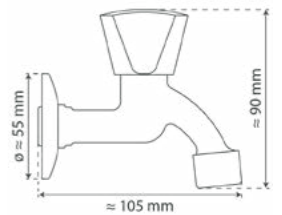



› 33100
Seite 62

› 10618
Seite 100



● 10618 4008431106182

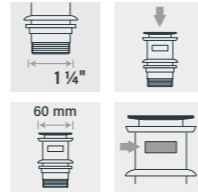

● W 98807410 4053452011830
● S 98807420 4053452011847

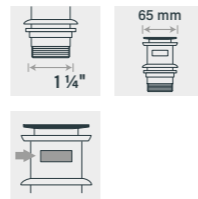

● 02238 4008431022383
● S 98807500 4053452022485

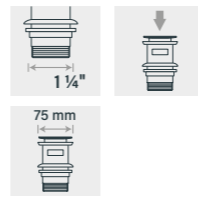

● 98807310 4053452025332
● S 98806840 4053452025325

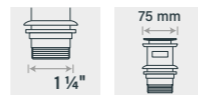

● 00660 4008431006604
● S 1202486 4008431024868



● 98166210 4007111501217
● S 98166220 4053452016446



● W 98833518 4053452019102



● 98166110 4007111501200
● S 98166120 4053452016415



● 10655 4008431106557



● M22/M24
● M22
● M24





Marken-Mischdüse für ein perfektes Strahlbild

EN | Brand name aerator for a perfect spray pattern
FR | Aérateur de marque pour un jet parfait
NL | Merk straalregelaar voor een perfect straalbeeld



Inkl. flexibler Anschlusschläuche

EN | Incl. flexible connection hoses
FR | Flexibles de raccordement inclus
NL | Incl. flexibele aansluitslangen



1/2" (Ø ca. 1,9 cm) Brauseschlauchanschluss

EN | 1/2" (Ø approx. 1,9 cm) shower hose connection
FR | Raccord du flexible de douche 1/2" (Ø env. 1,9 cm)
NL | 1/2" (Ø ca. 1,9 cm) verbinding voor doucheslang

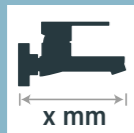

Ausladung der Armatur ca. x mm

EN | Saliency approx. x mm
FR | Saillie env. x mm
NL | Uitsteeksel ca. x mm



Inklusive Brausegarnitur

EN | Including shower set
FR | Garniture de douche incluse
NL | Inclusief doucheset



WANNENFÜLLARMATUREN

EN | BATH MIXERS

FR | MITIGEURS DE BAIN

NL | BADKRANEN



› 52470
Seite 106



LOS ANGELES

- 33190 4008431331904
- S 33196 4008431331966

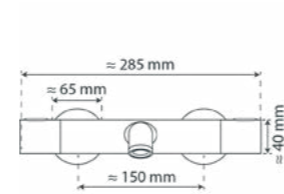
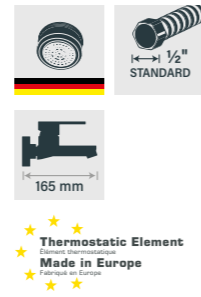

Thermostatic Element
 Element thermostatique
 Made in Europe
 Fabriqué en Europe



LONDON

- 52470 4008431524702
- S 52476 4008431524764

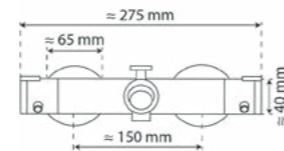
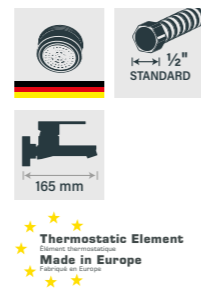

Thermostatic Element
 Element thermostatique
 Made in Europe
 Fabriqué en Europe



SUPRA

- 52440 4008431524405

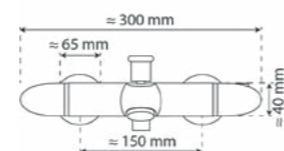

Thermostatic Element
 Element thermostatique
 Made in Europe
 Fabriqué en Europe



VICO

- 52450 4008431524504

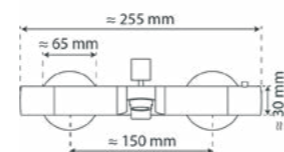

Thermostatic Element
 Element thermostatique
 Made in Europe
 Fabriqué en Europe



CORNWALL

- 75800 4008431758008

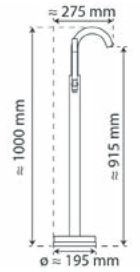

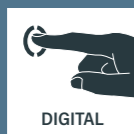

Mit Touch-Display

EN | With touch display
FR | Avec écran tactile
NL | Met aanraakscherm



Bis zu drei individuell speicherbare Benutzerprofile

EN | Up to three individually memorisable user profiles
FR | Jusqu'à trois profils d'utilisateur enregistrables individuellement
NL | Tot drie individueel op te slaan gebruikersprofielen



1/2" (Ø ca. 1,9 cm) Brauseschlauchanschluss

EN | 1/2" (Ø approx. 1,9 cm) shower hose connection
FR | Raccord du flexible de douche 1/2" (Ø env. 1,9 cm)
NL | 1/2" (Ø ca. 1,9 cm) verbinding voor doucheslang



Innovativer Kühlkanal schützt vor heißer Oberfläche

EN | Innovative cooling channel protects against hot surface
FR | Canal de refroidissement innovant évite une surface chaude
NL | Innovatieve kanaalkoeling beschermt tegen heet oppervlak



Thermostat-Element „Made in Europe“

EN | Thermostatic element „Made in Europe“
FR | Élément thermostatique „Made in Europe“
NL | Thermostatisch element „Made in Europe“



DUSCHARMATUREN

EN | SHOWER MIXERS

FR | MITIGEURS DE
DOUCHE

NL | DOUCHEKRANEN



BLUE TOPAZ
spirit of summer



SPA²
unisex
shower foam

lightweight of water mist and the
lifting care of argan oil
hydrate body and hair

menthyl + argan oil
7 FL OZ / 200 ml



BLUE TOPAZ
spirit of summer

SPA²
Shampoo

gentle cleanser with
moisturizing argan oil
hydrate body and hair

menthyl + argan oil
7 FL OZ / 200 ml



OCEAN

● W 60535 4008431605357



Thermostatic Element
 Europe Production
 Made in Europe
 Fabriqué en Europe

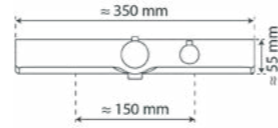

VITA

● 52425U 4008431096100



Thermostatic Element
 Europe Production
 Made in Europe
 Fabriqué en Europe

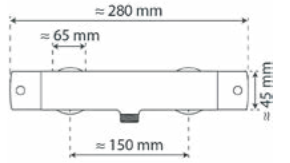

LOS ANGELES

● 33180 4008431331805

● S 33186 4008431331867



Thermostatic Element
 Europe Production
 Made in Europe
 Fabriqué en Europe

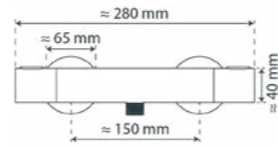

SIGNO

● 52485 4008431524856



Thermostatic Element
 Europe Production
 Made in Europe
 Fabriqué en Europe

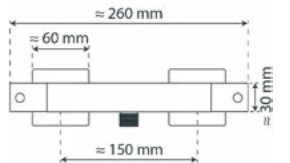

LONDON

● 52465 4008431524658

● S 52466 4008431524665



Thermostatic Element
 Europe Production
 Made in Europe
 Fabriqué en Europe

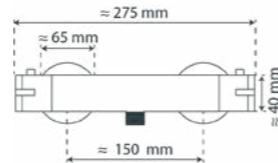

SUPRA

● 52435 4008431524351



Thermostatic Element
 Europe Production
 Made in Europe
 Fabriqué en Europe

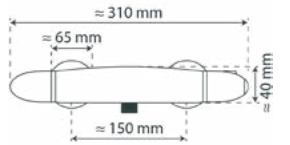

VINEA

● 52480 4008431524801



Thermostatic Element
 Europe Production
 Made in Europe
 Fabriqué en Europe

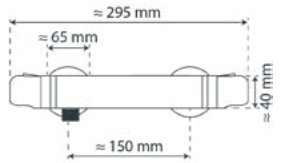

VICO

● 52445 4008431524450



Thermostatic Element
 Europe Production
 Made in Europe
 Fabriqué en Europe

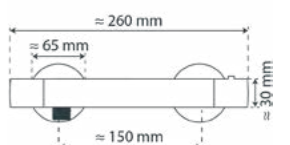



1/2" (Ø ca. 1,9 cm) Brauseschlauchanschluss

EN | 1/2" (Ø approx. 1,9 cm) shower hose connection
FR | Raccord du flexible de douche 1/2" (Ø env. 1,9 cm)
NL | 1/2" (Ø ca. 1,9 cm) verbinding voor doucheslang

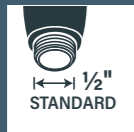

1/2" (Ø ca. 1,9 cm) Brauseschlauchanschluss

EN | 1/2" (Ø approx. 1,9 cm) shower hose connection
FR | Raccord du flexible de douche 1/2" (Ø env. 1,9 cm)
NL | 1/2" (Ø ca. 1,9 cm) verbinding voor doucheslang

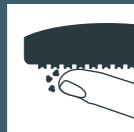

Antikalk-Noppen zur einfachen Entfernung von Kalkrückständen

EN | Anti-limescale nozzles for easy removal of limescale residue
FR | Picots anti-calcaire pour une élimination facile des résidus de calcaire
NL | Antikalk nozzles voor eenvoudige verwijdering van kalkresten



Bis zu 50 % Wasser sparen bei Benutzung der Handbrause (gegenüber einer Standardhandbrause mit einem Durchfluss von 16l/min bei 3 bar Fließdruck)

EN | Save up to 50 % water when using the hand shower (compared to a standard hand shower with a flow rate of 16l/min at 3 bar flow pressure)

FR | Économiser jusqu'à 50 % d'eau en utilisant la douchette à main (par rapport à une douchette standard avec un débit de 16l/min à 3 bar de pression d'écoulement)

NL | Bespaar tot 50% water bij gebruik van de handdouchette (vergeleken met een standaard handdouchette met een debiet van 16l/min bij 3 bar doorstroomdruk)

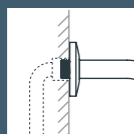

Unterputzmontage

EN | Flush mounting
FR | Montage encastré
NL | Inbouw



Thermostat-Element „Made in Europe“

EN | Thermostatic element „Made in Europe“
FR | Élément thermostatique „Made in Europe“
NL | Thermostatisch element „Made in Europe“



DUSCHPANEELE ÜBERKOPFBRAUSE-SETS STANGENBRAUSE-SETS

EN | SHOWER PANELS
RAINSHOWERS
SHOWER BAR SETS

FR | PANNEAUX DE DOUCHE
DOUCHES DE PLUIE
SETS BARRE DE DOUCHE

NL | DOUCHEPANELEN
REGENDOUCHES
DOUCHESTANGSETS



> 60660
Seite 128

Unsere Wellness-Regenduschen bieten ein luxuriöses Duscherlebnis, das durch sanfte Wasserstrahlen den Körper wie ein warmer Sommerregen umhüllt. Sie schaffen eine Oase der Entspannung im eigenen Zuhause, fördern die Regeneration und lassen den Alltagsstress sanft abperlen.

EN | Our wellness rain showers offer a luxurious shower experience with gentle jets of water that envelop the body like a warm summer rain. They create an oasis of relaxation in your own home, promote regeneration and allow everyday stress to gently roll off.

FR | Nos douches à effet pluie offrent une expérience de douche luxueuse, enveloppant le corps de doux jets d'eau comme une chaude pluie d'été. Elles créent une oasis de détente à domicile, favorisent la régénération et permettent au stress quotidien de s'écouler doucement.

NL | Onze wellness regendouches bieden een luxueuze douche-ervaring met zachte waterstralen die het lichaam omhullen als een warme zomerregen. Ze creëren een oase van ontspanning in uw thuis, bevorderen de regeneratie en laten de stress van alledag zachtjes van u afglijden.



Regen

EN | Rain
FR | Pluie
NL | Regen



Regen

EN | Rain
FR | Pluie
NL | Regen



Massage

EN | Massage
FR | Massage
NL | Massage



Regen/Massage

EN | Rain/massage
FR | Pluie/massage
NL | Regen/massage



Sauna

EN | Sauna
FR | Sauna
NL | Sauna



Regen/Sauna

EN | Rain/sauna
FR | Pluie/sauna
NL | Regensauna



Soft

EN | Soft
FR | Soft
NL | Soft



Regen/Soft

EN | Rain/soft
FR | Pluie/soft
NL | Regen/soft



Mini Regen

EN | Mini rain
FR | Mini-pluie
NL | Miniregen



Schwall

EN | Surge
FR | Rivière d'eau
NL | Watergolf



Energie

EN | Energy
FR | Énergie
NL | Energie



Wasserstopp

EN | Water stop
FR | Stop-eau
NL | Waterstop





LANZAROTE III

W 60025 4008431600253
S 60029 4008431600291

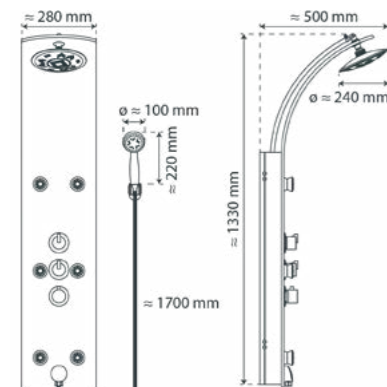

GLAS-DUSCHPANEEL

A 60033 4008431600338

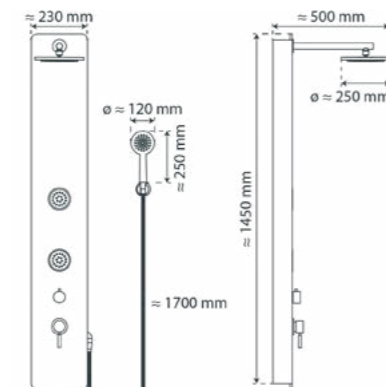

TAHITI

60035 4008431600352

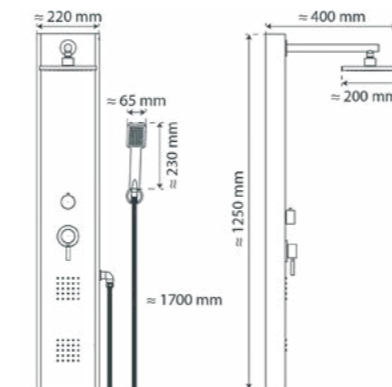
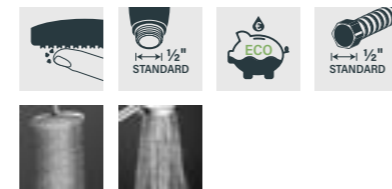



Thermostatic Element
 Made in Europe

OCEAN

- W 60530 4008431605302
- A 60531 4008431605319

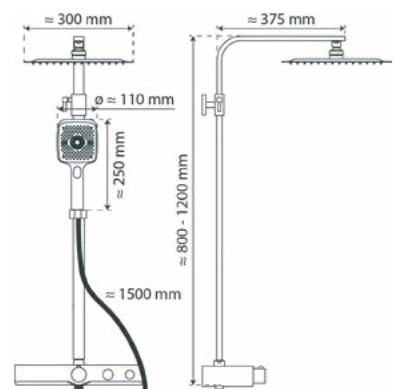
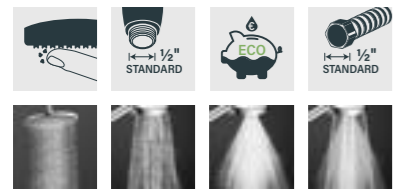

> 60530 4008431605302

> 60531 4008431605319



HAWAII

- W 60585 4008431605852
- S 60586 4008431605869
- G 60587 4008431605876

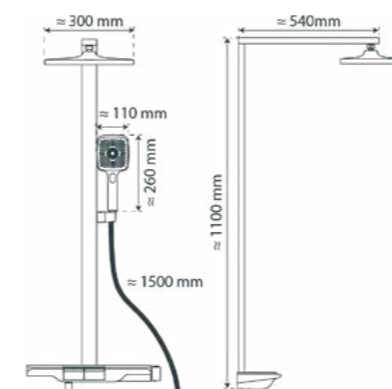
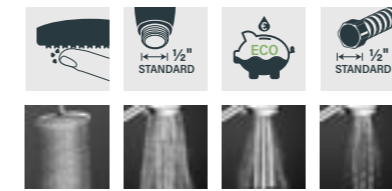



AQUADUCT

- 60044 4008431600444
- S 60074 4008431600741

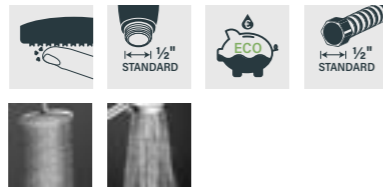

GRAN CANARIA

- 60149 4008431601496
- S 60179 4008431601793

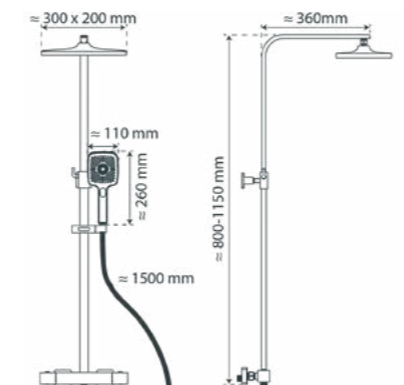
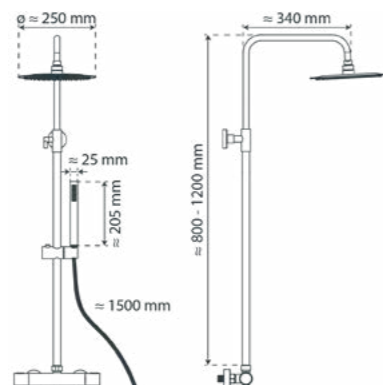



MADURA FRESH

- 60046 4008431600468
- S 60076 4008431600765

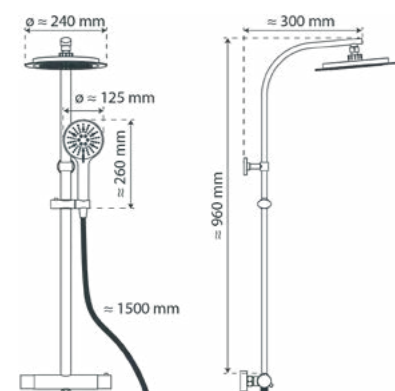
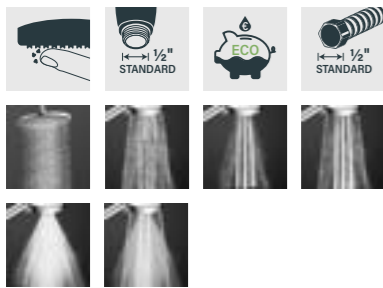

TRENTO

- 60140 4008431601403
- S 60170 4008431601700

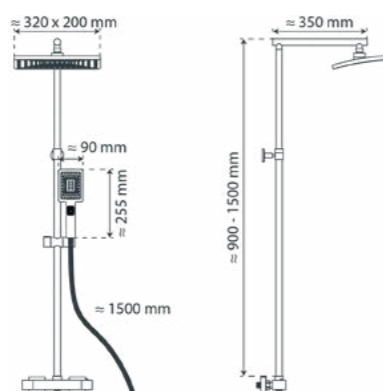
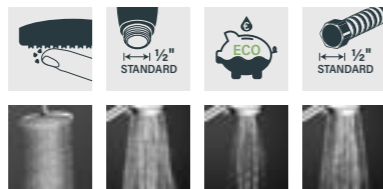

ADRIA

- S 60171 4008431601717

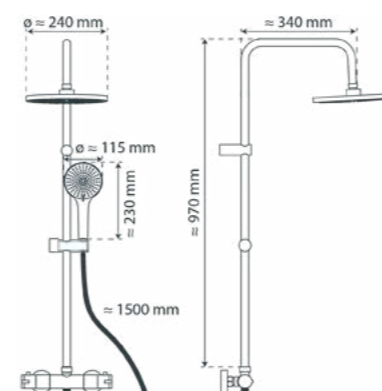
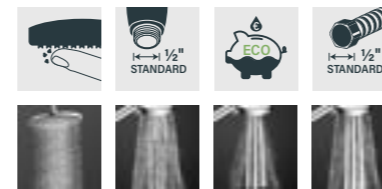

JAVA

- 60080U 4008431600802

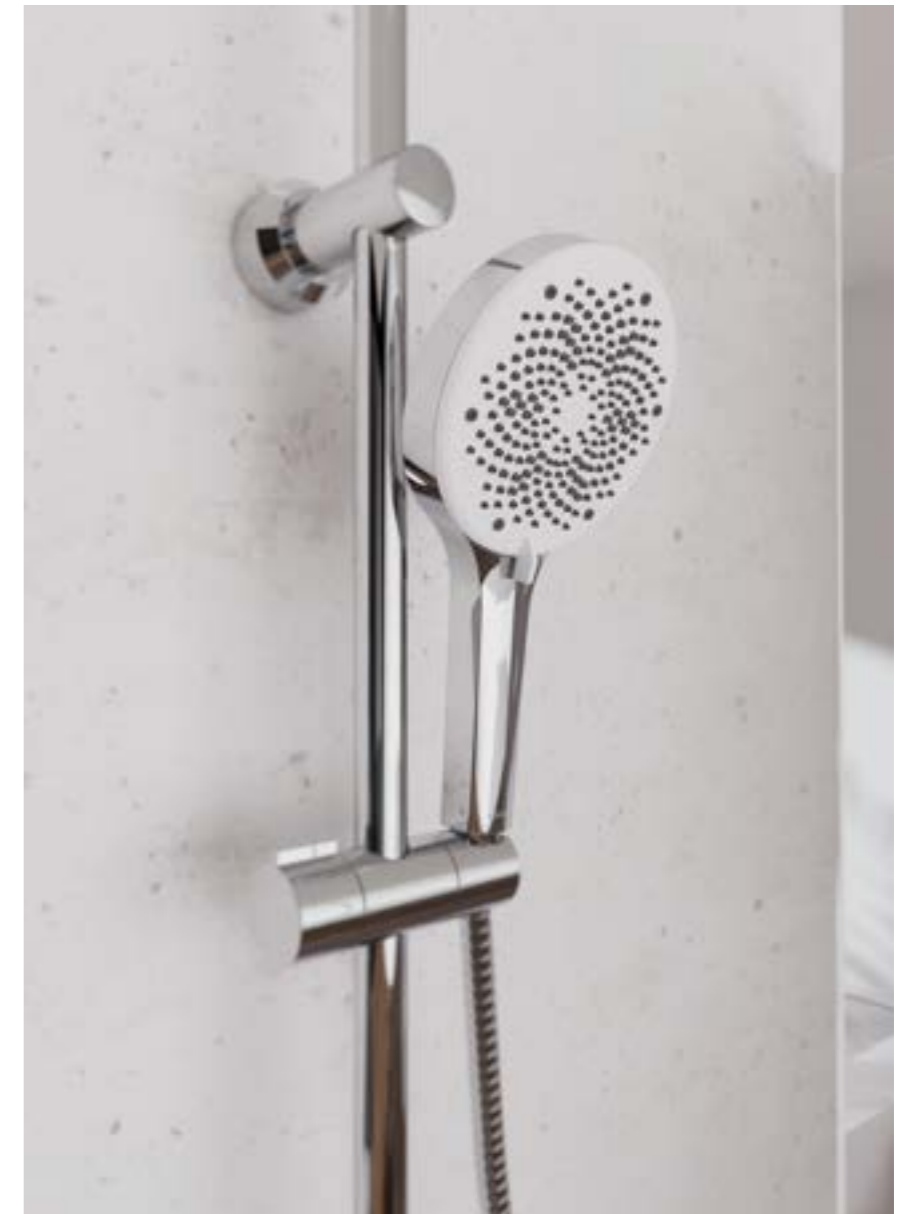
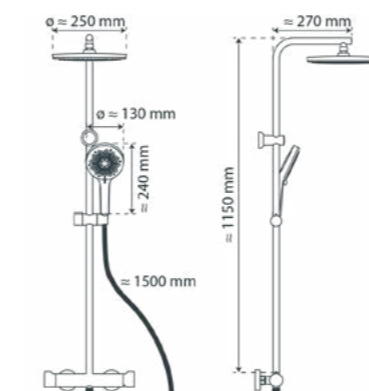
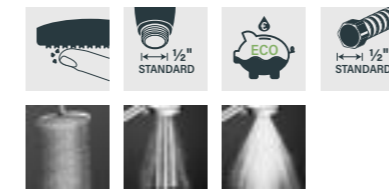



LA PALMA

- W 60685 4008431606859
- S 60686 4008431606866
- G 60687 4008431606873

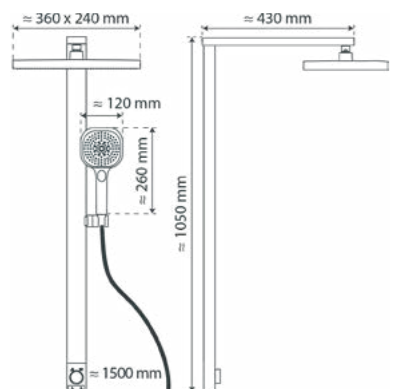
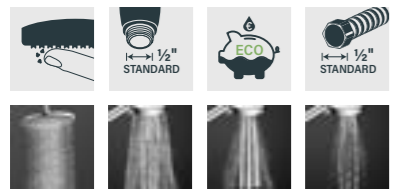

AQUASTAR

- W 60500 4008431605005
- A 60501 4008431605012

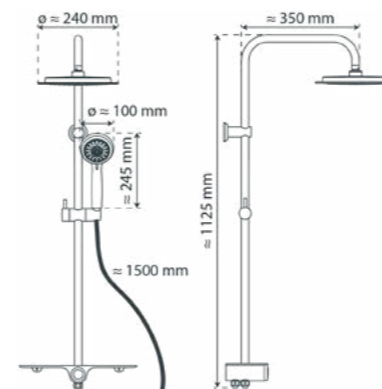
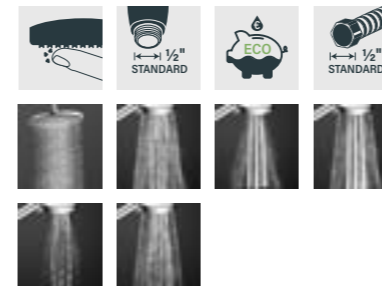



MALLORCA

● 60660 4008431606606
 ● S 60666 4008431606668

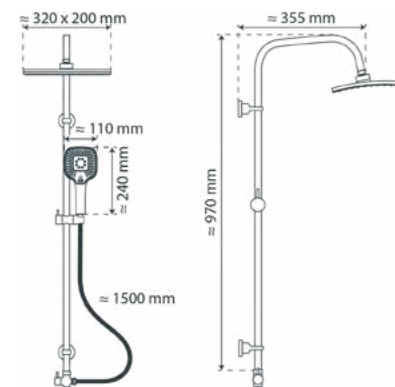
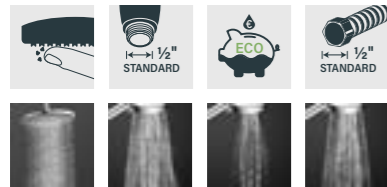

MADEIRA

● 60690 4008431606903

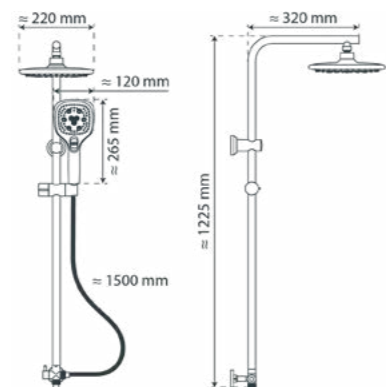
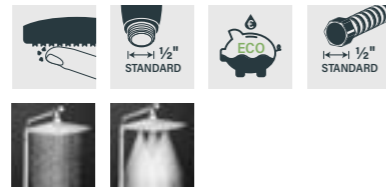

MADAGASKAR

● S 60060 4008431600604
 ● W 60065 4008431600659

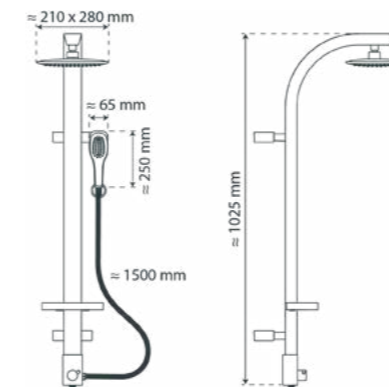
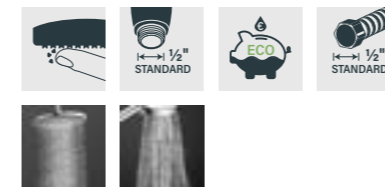

TOKYO

● 60090 4008431600901
 ● S 60096 4008431600963

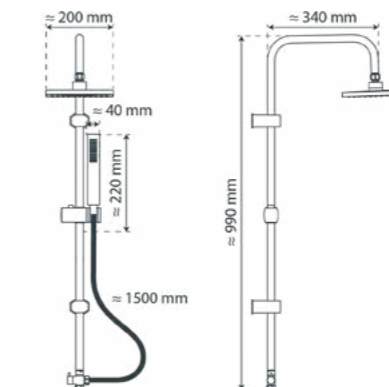
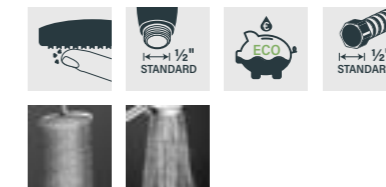

JAMAICA FRESH

● 60050 4008431600505

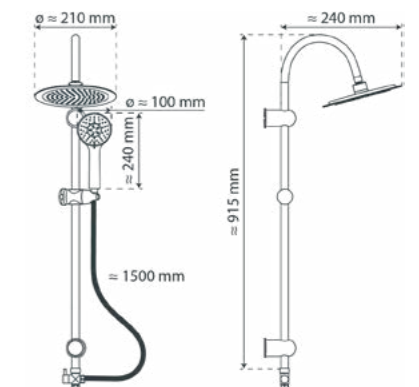
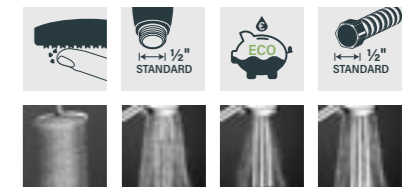



› 60666
Seite 128

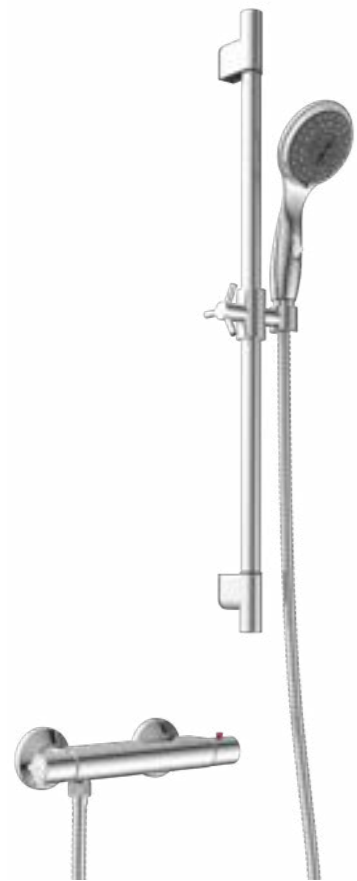

AQUA 2 SAVE

● 52545 4008431525457

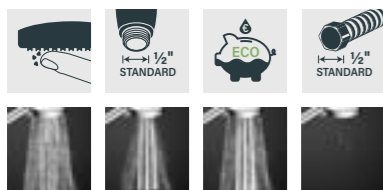

ZUM KLEBEN ODER BOHREN

● 64841 4008431648415

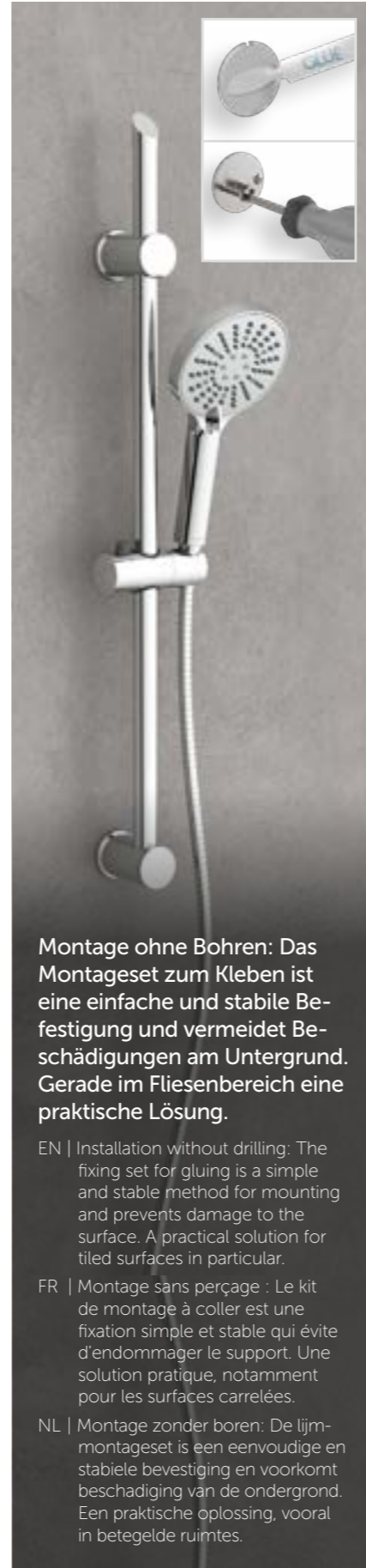
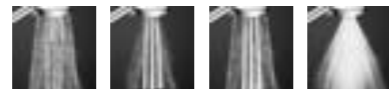

Montage ohne Bohren: Das Montageset zum Kleben ist eine einfache und stabile Befestigung und vermeidet Beschädigungen am Untergrund. Gerade im Fliesenbereich eine praktische Lösung.

EN | Installation without drilling: The fixing set for gluing is a simple and stable method for mounting and prevents damage to the surface. A practical solution for tiled surfaces in particular.

FR | Montage sans perçage : Le kit de montage à coller est une fixation simple et stable qui évite d'endommager le support. Une solution pratique, notamment pour les surfaces carrelées.

NL | Montage zonder boren: De lijm-montageset is een eenvoudige en stabiele bevestiging en voorkomt beschadiging van de ondergrond. Een praktische oplossing, vooral in betegelde ruimtes.

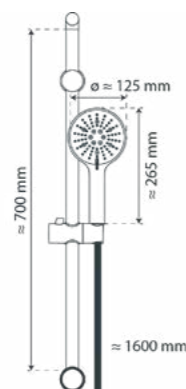
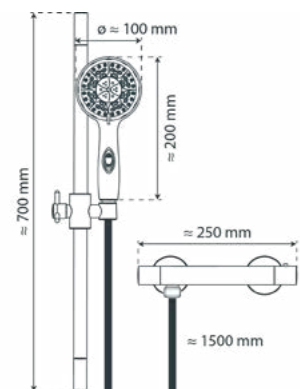

FRESH

● 64160 4008431641607

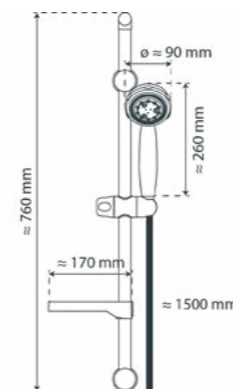
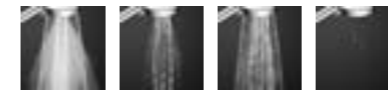
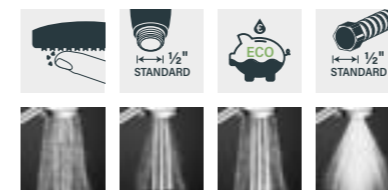

ADRIA

● 64860 4008431648606

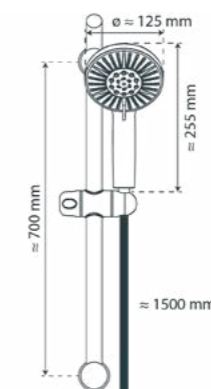
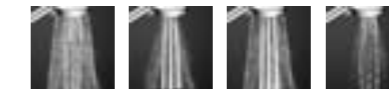
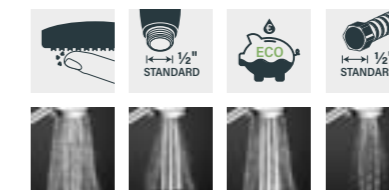

FLORENZ

● 64870 4008431648705

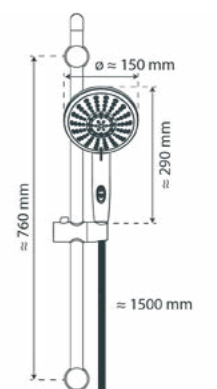
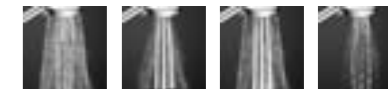
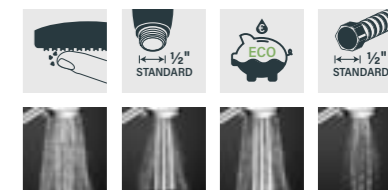



LIANA

● 64820 4008431648200

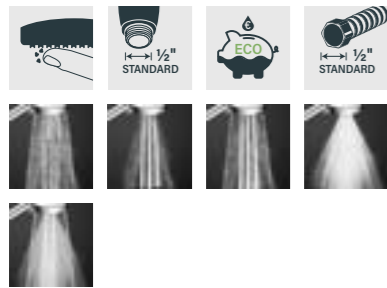

NAPOLI

● 64830 4008431648309



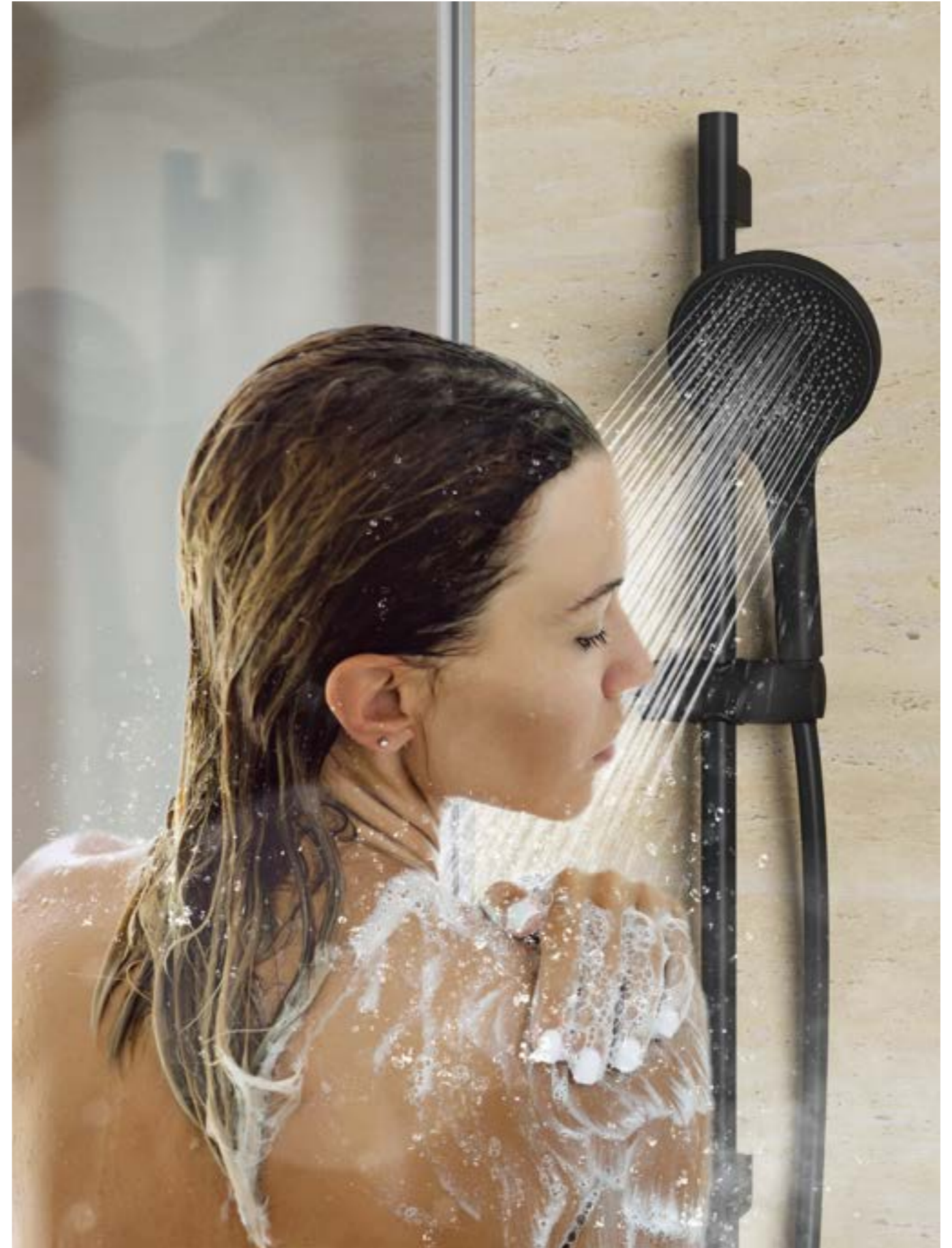
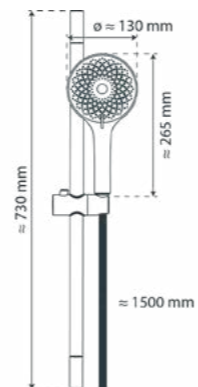
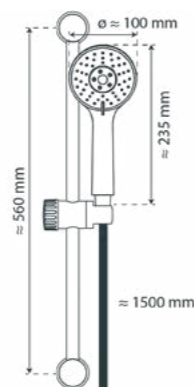
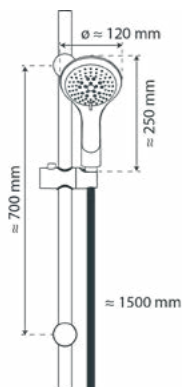
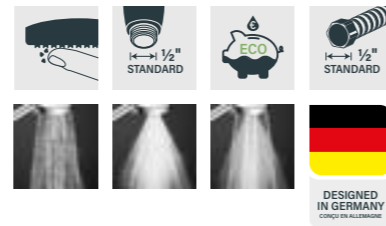

CAPRI

● 64291 4008431642918
 ● S 64296 4008431642963





KARIBIK

-  64200 4008431642000
-  64202 4008431642024
-  64206 4008431642062

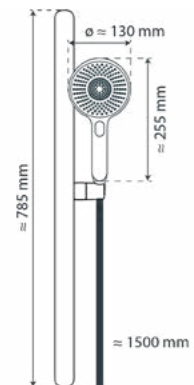
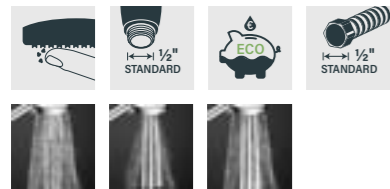

RAVENNA

-  64801 4008431648019

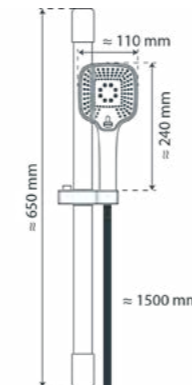
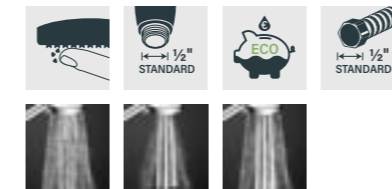

RAVEN

-  64926 4008431649269

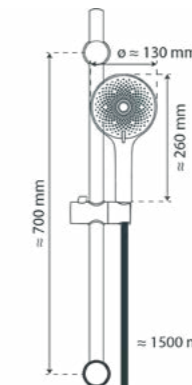
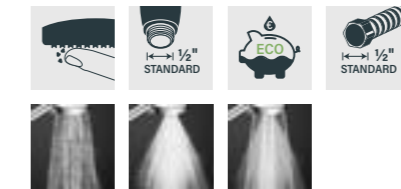



1/2" (Ø ca. 1,9 cm) Brauseschlauchanschluss

EN | 1/2" (Ø approx. 1,9 cm) shower hose connection
FR | Raccord du flexible de douche 1/2" (Ø env. 1,9 cm)
NL | 1/2" (Ø ca. 1,9 cm) verbinding voor doucheslang



1/2" (Ø ca. 1,9 cm) Brauseschlauchanschluss

EN | 1/2" (Ø approx. 1,9 cm) shower hose connection
FR | Raccord du flexible de douche 1/2" (Ø env. 1,9 cm)
NL | 1/2" (Ø ca. 1,9 cm) verbinding voor doucheslang

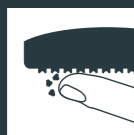

Antikalk-Noppen zur einfachen Entfernung von Kalkrückständen

EN | Anti-limescale nozzles for easy removal of limescale residue
FR | Picots anti-calcaire pour une élimination facile des résidus de calcaire
NL | Antikalk nozzles voor eenvoudige verwijdering van kalkresten



Langlebig und robust durch massiven Edelstahl

EN | Durable and robust due to solid stainless steel
FR | Durable et robuste grâce à l'acier inoxydable massif
NL | Duurzaam en robuust dankzij massief roestvrij staal



Bis zu 50 % Wasser sparen bei Benutzung der Handbrause (gegenüber einer Standardhandbrause mit einem Durchfluss von 16l/min bei 3 bar Fließdruck)

EN | Save up to 50 % water when using the hand shower (compared to a standard hand shower with a flow rate of 16l/min at 3 bar flow pressure)
FR | Économiser jusqu'à 50 % d'eau en utilisant la douchette à main (par rapport à une douchette standard avec un débit de 16l/min à 3 bar de pression d'écoulement)
NL | Bespaar tot 50% water bij gebruik van de handdouchette (vergeleken met een standaard handdouchette met een debiet van 16l/min bij 3 bar doorstroomdruk)



Besonders knickfest dank Anti-Twist Funktion

EN | Particularly kink-resistant thanks to anti-twist function
FR | Particulièrement résistant aux plis grâce à la fonction anti-twist
NL | Bijzonder knikbestendig dankzij de antikronkelfunctie

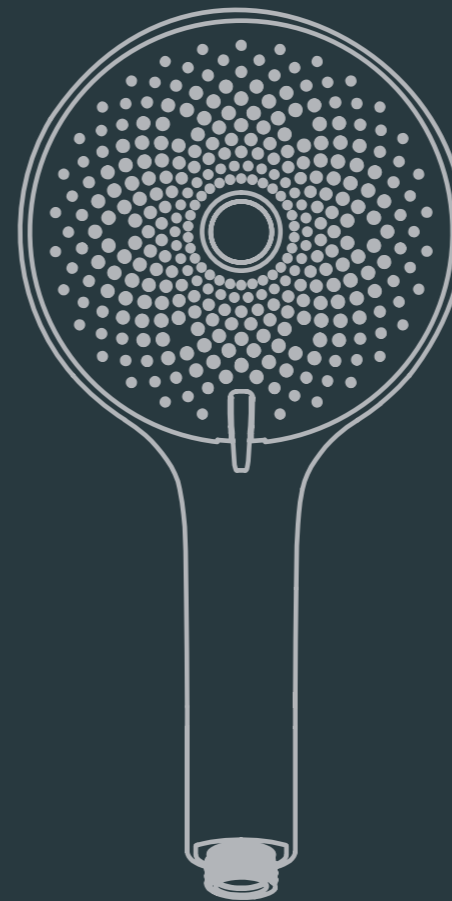

HANDBRAUSE-SETS HANDBRAUSEN BRAUSESCHLÄUCHE KOPFBRAUSEN

EN | HAND SHOWER SETS

HAND SHOWERS

SHOWER HOSES

HEAD SHOWERS

FR | SETS DE DOUCHE

DOUCHETTES

FLEXIBLES DE DOUCHE

DOUCHES DE TÊTE

NL | HANDDOUCHESETS

HANDDOUCHES

DOUCHESLANGEN

HOOFDDOUCHES



< 50 % WATER SAVE

Unsere Handbrausen mit Wasserspardichtung bieten eine effektive Möglichkeit, den Wasserverbrauch zu reduzieren, ohne dabei auf Komfort zu verzichten. Die innovative Technik sorgt für einen gleichmäßigen Wasserfluss, während wertvolle Ressourcen geschont werden. Setzen Sie auf Nachhaltigkeit und sparen Sie Wasser, ohne Kompromisse bei der Leistung einzugehen.

EN | Our hand showers with a water-saving seal offer an effective way to reduce water consumption without compromising on comfort. Innovative technology ensures an even flow of water while conserving valuable resources. Focus on sustainability and save water without compromising on performance.

FR | Nos douchettes à main avec joint d'économie d'eau offrent un moyen efficace de réduire la consommation d'eau sans pour autant renoncer au confort. La technique innovante assure un débit d'eau régulier tout en préservant les précieuses ressources. Misez sur la durabilité et économisez de l'eau sans faire de compromis sur les performances.

NL | Onze handdouches met een waterbesparende afdichting bieden een effectieve manier om het waterverbruik te verminderen zonder afbreuk te doen aan het comfort. De innovatieve technologie zorgt voor een gelijkmatige waterstroom terwijl waardevolle bronnen worden bespaard. Focus op duurzaamheid en bespaar water zonder aan prestaties in te boeten.



ADRIA

● 61861 4008431618616

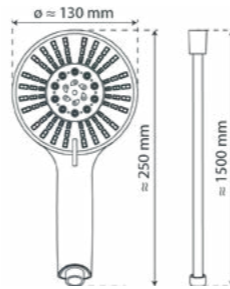
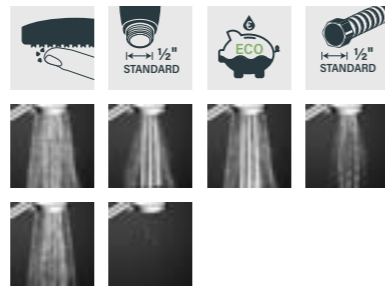

TORINO

● 61850 4008431618500

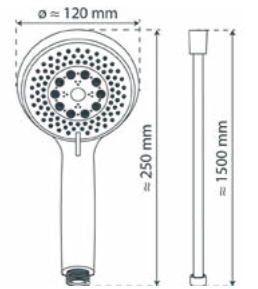
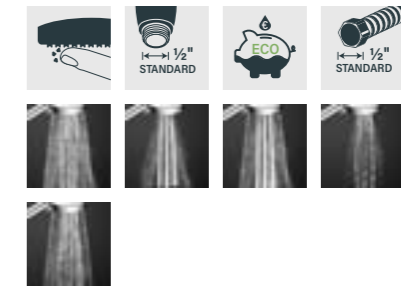

BROADWAY

● W 61766 4008431617664

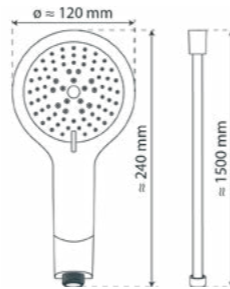
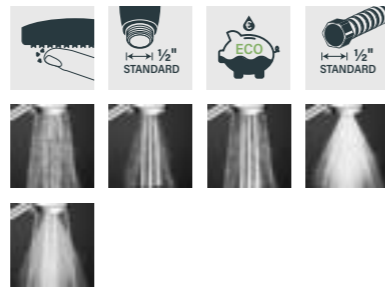

HANDBRAUSE-SET

● 64197 4008431641973

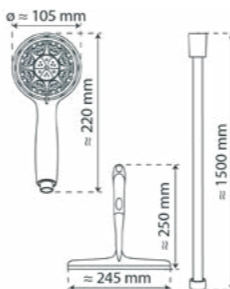

NAPOLI

● 61831 4008431618319

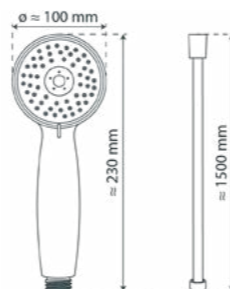
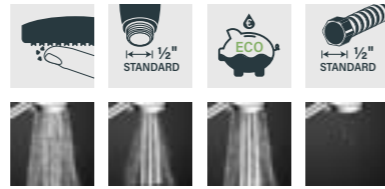

RAVEN

● S 61926 4008431619262

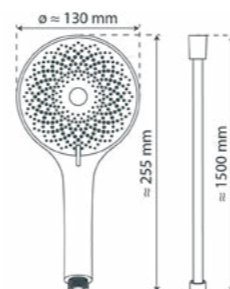
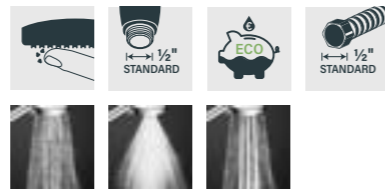



NIAGARA

● 60751 4008431607511

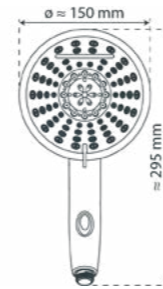
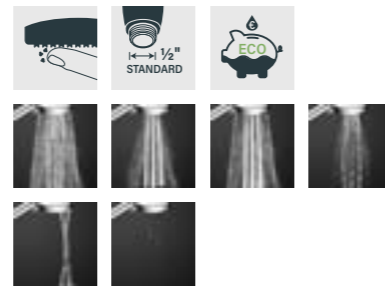

BROADWAY

● S 60761 4008431607610
● W 60766 4008431607665

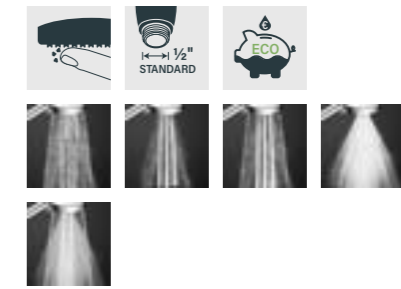

TOSCANA II

● 60936 4008431609362

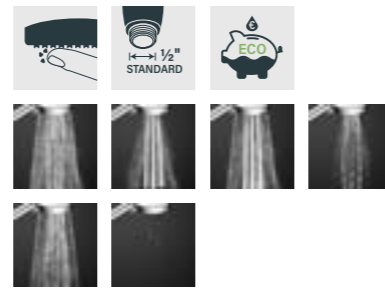

GALAXIS LED

● 60783 4008431607832

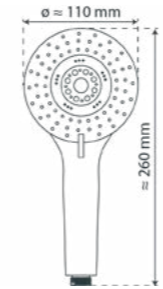
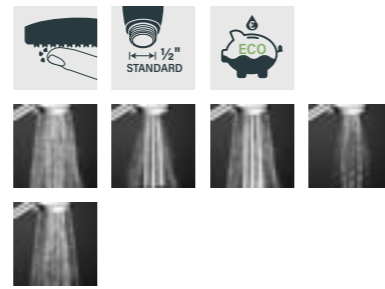

TROPIC

● 60711 4008431607115

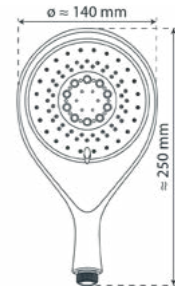
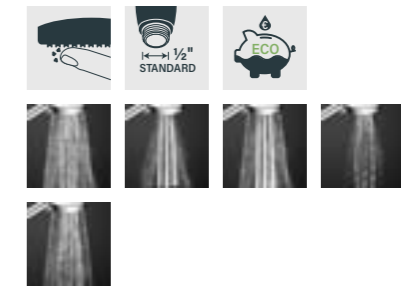

Sieben Farbvarianten an der Duschbrause sorgen für Spaß und pure Entspannung. Der LED Lichtwechsel erfolgt alle 5 Sekunden und basiert auf Wasserkraft ohne den Einsatz von Batterien.

GB | Seven colour variations on the shower head ensure fun and pure relaxation. The LED light changes every 5 seconds and is based on water power without the use of batteries.

FR | Sept variantes de couleurs sur le pommeau de douche garantissent le plaisir et la pure détente. Le changement de lumière LED s'effectue toutes les 5 secondes et se base sur l'énergie hydraulique sans utiliser de piles.

NL | Zeven kleurvarianties op de douchekop zorgen voor plezier en pure ontspanning. Het LED-lampje verandert om de 5 seconden en werkt op waterkracht, zonder gebruik van batterijen.



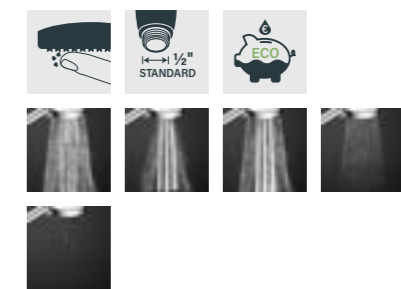

AQUA 2 SAVE

● 60791 4008431607917

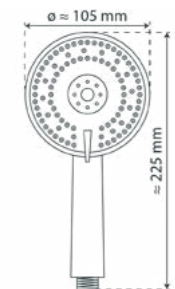
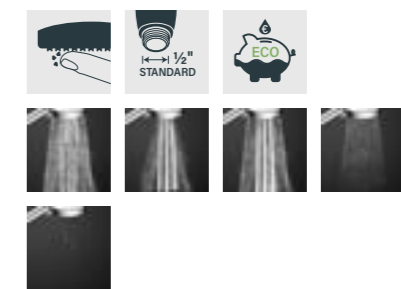

VENEZIA

● 60821 4008431608211





FABIA II

● 60896 4008431608969

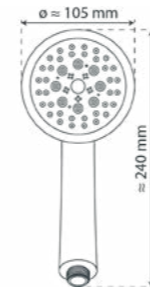
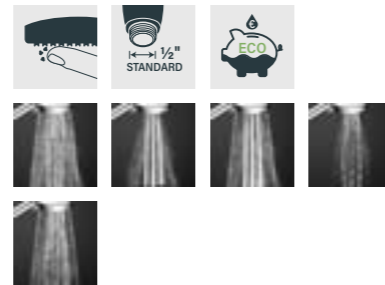

CAPRI

● A 60291 4008431602912
 ● W A 60294 4008431602943
 ● W 60295 4008431602950
 ● S 60296 4008431602967

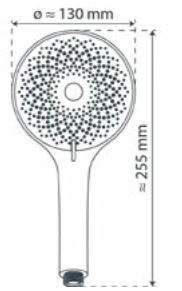
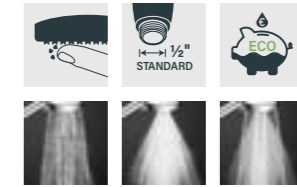

COMO

● 60862 4008431608624

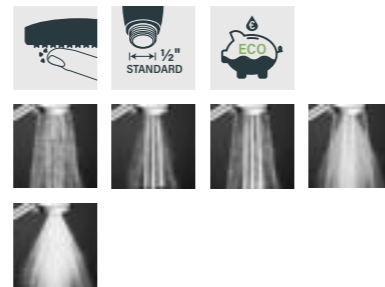

VITAL

● A 60971 4008431609713

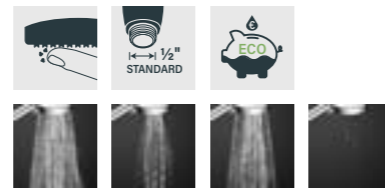

BARI

● 60811 4008431608112

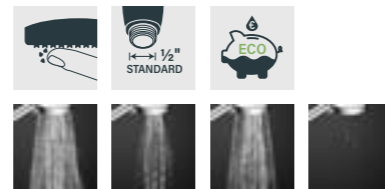

NAPOLI

● 60740 4008431607405

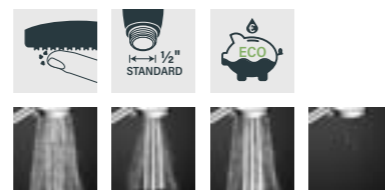

SAMOA RAIN

● A 60251 4008431602516
 ● W 60252 4008431602523
 ● S 60256 4008431602561

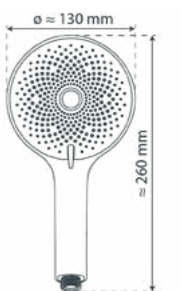
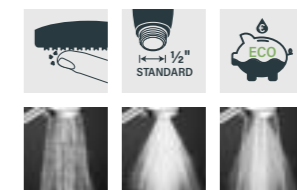



SUMATRA

W 60230 4008431602301

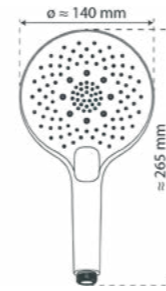
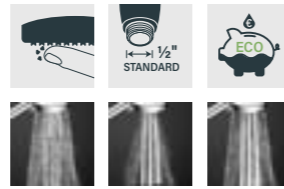

KARIBIK

60200 4008431602004
 60202 4008431602028
 S 60203 4008431602035

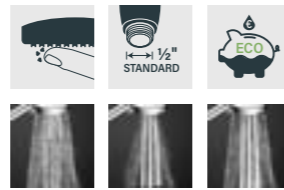

HAWAII

60220 4008431602202
 60222 4008431602226
 S 60226 4008431602264

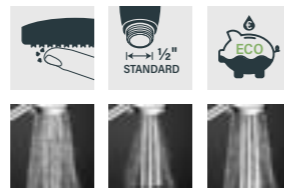

RAVENNA

60801 4008431608013
 S 60807 4008431608075

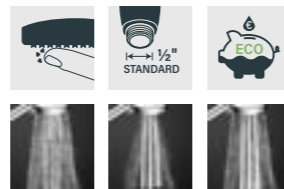



IBIZA

● W 60260 4008431602608
 ● S A 60266 4008431602660

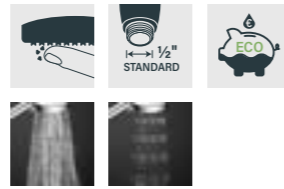

GENUA

● 60771 4008431607719

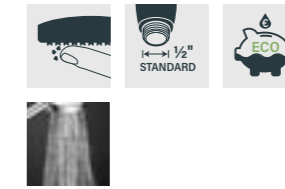

RIMINI

● 60720 4008431607207

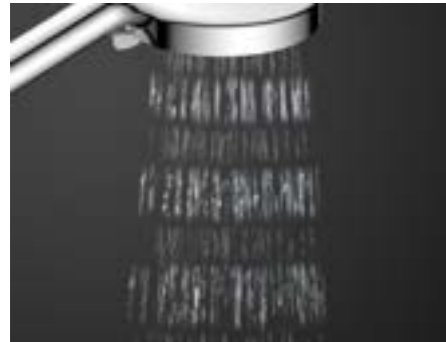
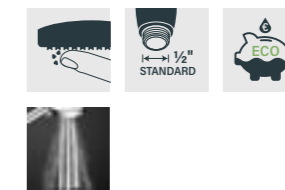

BELLAQUA

● 60700 4008431607009

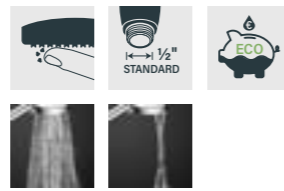

ANTEA

● 60730 4008431607306

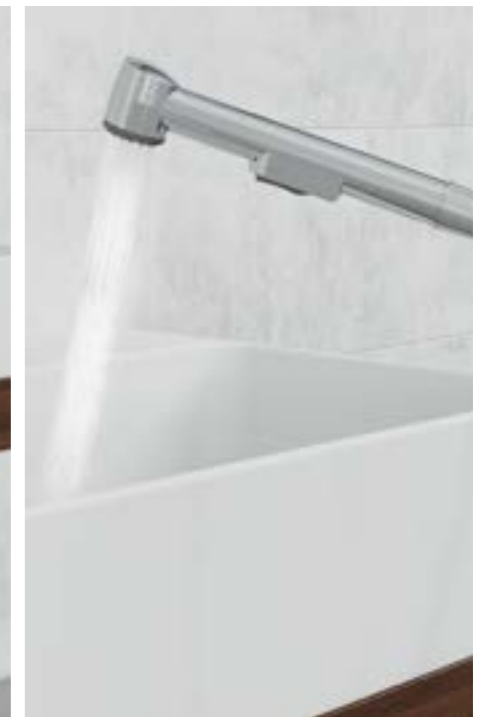
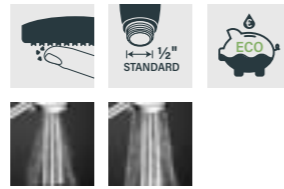

ROMA

● W 60961 4008431609614

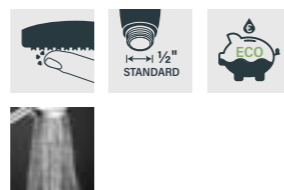

WASCHBECKENBRAUSE

● 78016 4008431092171

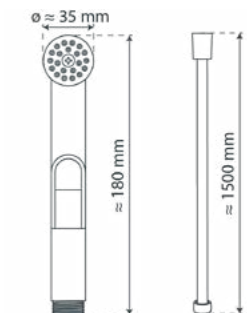
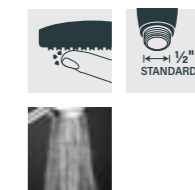



- 80 cm 63431 4008431634319
- 125 cm 63441 4008431634418
- 150 cm 63451 4008431634517
- 175 cm 63471 4008431634715
- 200 cm 63461 4008431634616



- 150 cm 63550 4008431635507
- 200 cm 63560 4008431635606



- S 150 cm 63852 4008431638522
- S 200 cm 63861 4008431638614



- 150 cm 63870 4008431638706



- S 150 cm 63981 4008431639819
- S 200 cm 63961 4008431639611



- W 150 cm 63802 4008431638027



- W 150 cm 63878 4008431638782



- 150 cm 63872 4008431638720





- S 80 cm 63867 4008431638676
- S 150 cm 63877 4008431638676
- S 200 cm 63887 4008431638874





CAPRI

-  69291 4008431692913
-  69292 4008431692920
-  69293 4008431692937

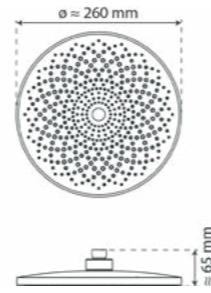
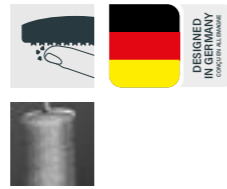

Mit Samtstrahl – Über 300 Brausedüsen erzeugen einen zarten Wasserdampf

EN | With velvet spray – Over 300 shower nozzles create a delicate water mist

FR | Avec jet velouté – Plus de 300 buses produisent un jet aux gouttelettes microscopiques

NL | Met fluwelen spray – Meer dan 300 spraynozzles zorgen voor een delicate waternevel



SUMATRA

-  69242 4008431692425

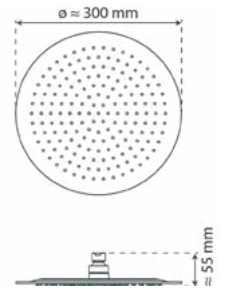

JAVA

-  69243 4008431692432

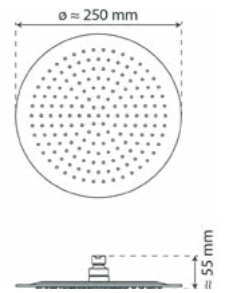

TOULOUSE

-  69208 4008431692081

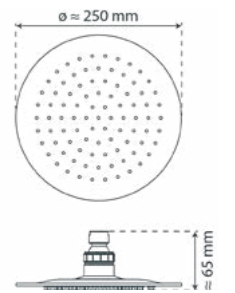

SUMBA

-  69249 4008431692494

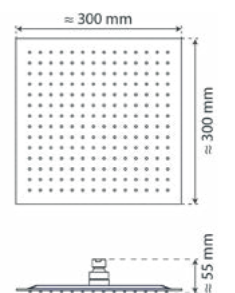

STRASBOURG

-  69207 4008431692074

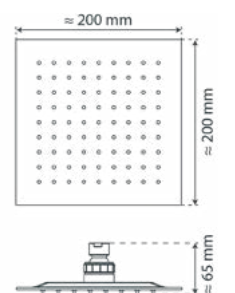



LE MANS

● 69206 4008431692067

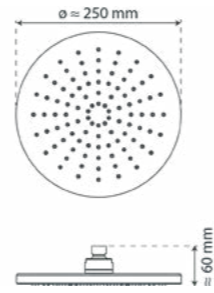
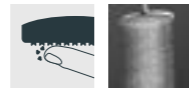

AUXERRE

● 69203 4008431692036

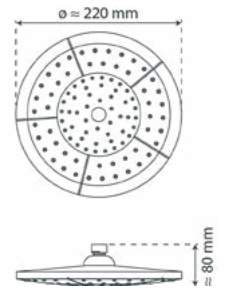
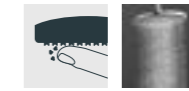

MADURA

● 60947 4008431609478

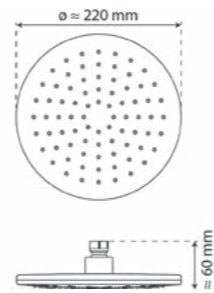
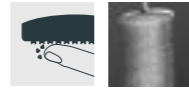

LEON

● 69201 4008431692012

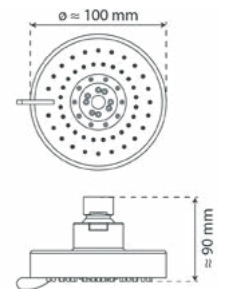
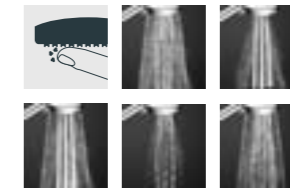

GRENOBLE

● 69204 4008431692043

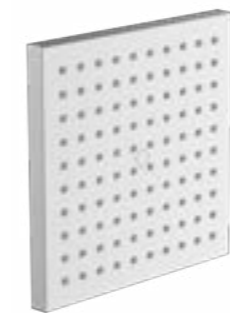
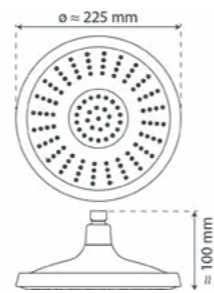
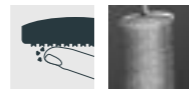

NANCY

● 69205 4008431692050

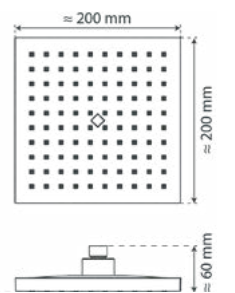

LYON

● 69212 4008431692128

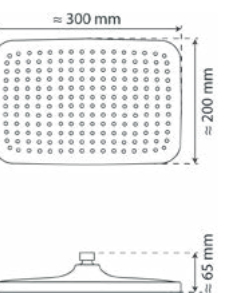
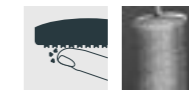

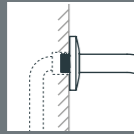

Unterputzmontage, Wand

EN | Flush mounting, wall
FR | Montage encastré, mural
NL | Inbouw, wand

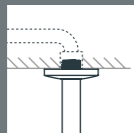

Unterputzmontage, Decke

EN | Flush mounting, ceiling
FR | Montage encastré, plafond
NL | Inbouw, plafond

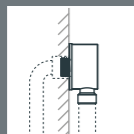

Unterputzmontage, Schlauchanschluss

EN | Flush mounting, hose connection
FR | Montage encastré, raccord de flexible
NL | Inbouw, slangaansluiting

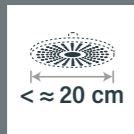

Für eine Kopfbrause mit max. Ø 20 cm

EN | For a head shower with max. Ø 20 cm
FR | Pour une douche de tête avec Ø max. 20 cm
NL | Voor een hoofddouche met max. Ø 20 cm

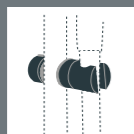

Schieber für Wandstange

EN | Slider for wall bar
FR | Coulissant pour barre murale
NL | Schuifregelaar voor wandstang

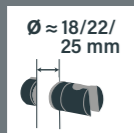

Für eine Wandstange mit Ø 18/22/25 mm

EN | For a wall bar with Ø 18/22/25 mm
FR | Pour une barre murale de Ø 18/22/25 mm
NL | Voor een wandstang met Ø 18/22/25 mm

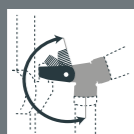

Drehbares Gelenkstück

EN | Rotatable joint
FR | Articulation pivotante
NL | Draaibaar knie



BADAUSSTATTUNG

EN | BATHROOM EQUIPMENT

FR | ÉQUIPEMENT DE
SALLE DE BAINS

NL | BADKAMERINRICHTING



MARSEILLE

● 69401 4008431694016



KARIBIK

● 67200 4008431672007
 S 67206 4008431672069

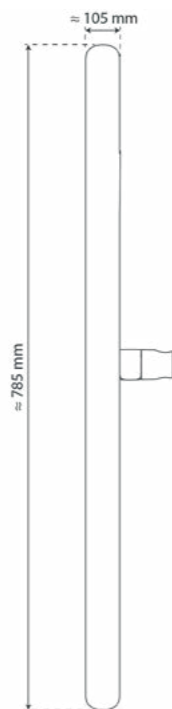
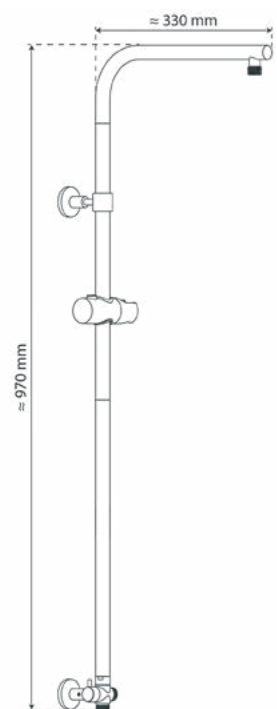

STILO

● 67151 4008431671512



SIGNO

● 67131 4008431671314



STELLA

● 67111 4008431671116

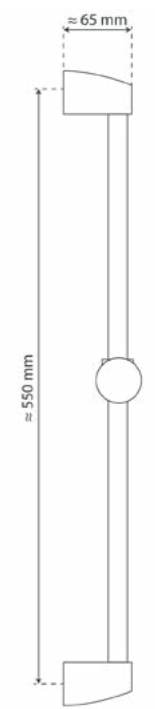
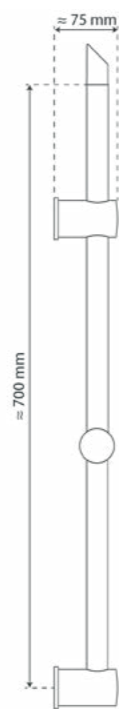
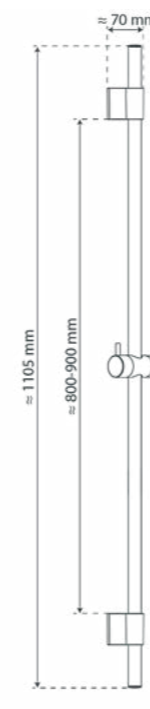



● 66340 4008431663401

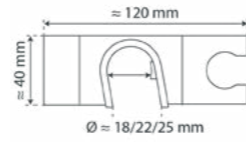
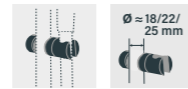

LONDON

● 10112 4008431101125



● 66111 4008431661117
 ● S 66116 4008431661162

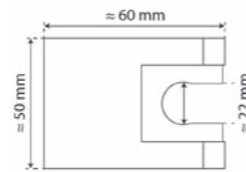

LONDON

● 10114 4008431101149



● 66121 4008431661216

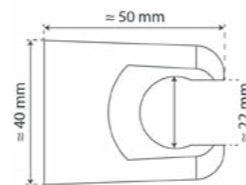

LONDON

● 10113 4008431101132



● 66421 4008431664217

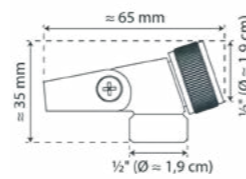

LONDON

● 10115 4008431101156



AVIGNON

● 69511 4008431695112

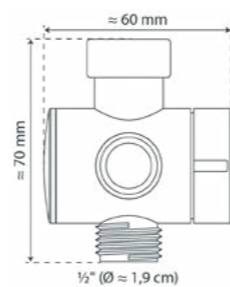

LONDON

● 10016 4008431100166

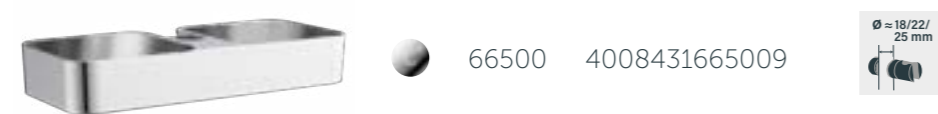

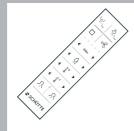

Inkl. Fernbedienung

EN | Incl. remote control
FR | Télécommande inclus
NL | Incl. afstandsbediening

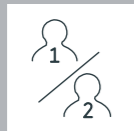

2 speicherbare Benutzerprofile

EN | 2 programmable user profiles
FR | 2 profils d'utilisateurs programmables
NL | 2 programmeerbare gebruikersprofielen

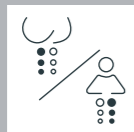

Gesäß-/Ladydusche

EN | Rear wash/Lady wash
FR | Douchette rectale/dame
NL | Billen-/ladydouche

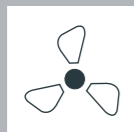

Warmlufttrockner (5 Stufen)

EN | Hot air dryer (5 stages)
FR | Séchoir à air chaud (5 niveaux)
NL | Warme lucht droger (5 standen)

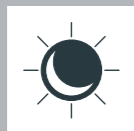

Nachtlicht

EN | Night light
FR | Lumière nocturne
NL | Nachtlampje

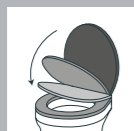

Geräuschloses Schließen dank Absenkautomatik

EN | Noiseless closing thanks to the soft closing hinges
FR | Fermeture silencieuse grâce aux charnières avec frein de chute
NL | Geruisloos sluiten dankzij de scharnieren met valrem



DUSCH-WC

EN | SHOWER WC
FR | WC LAVANT
NL | DOUCHE WC



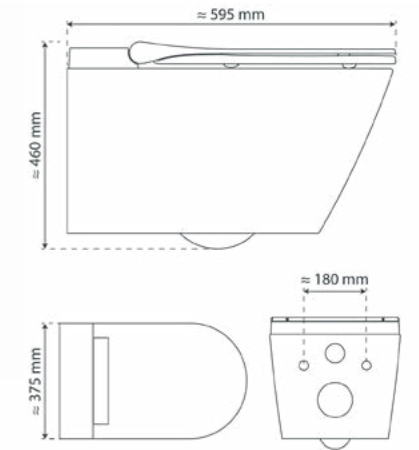
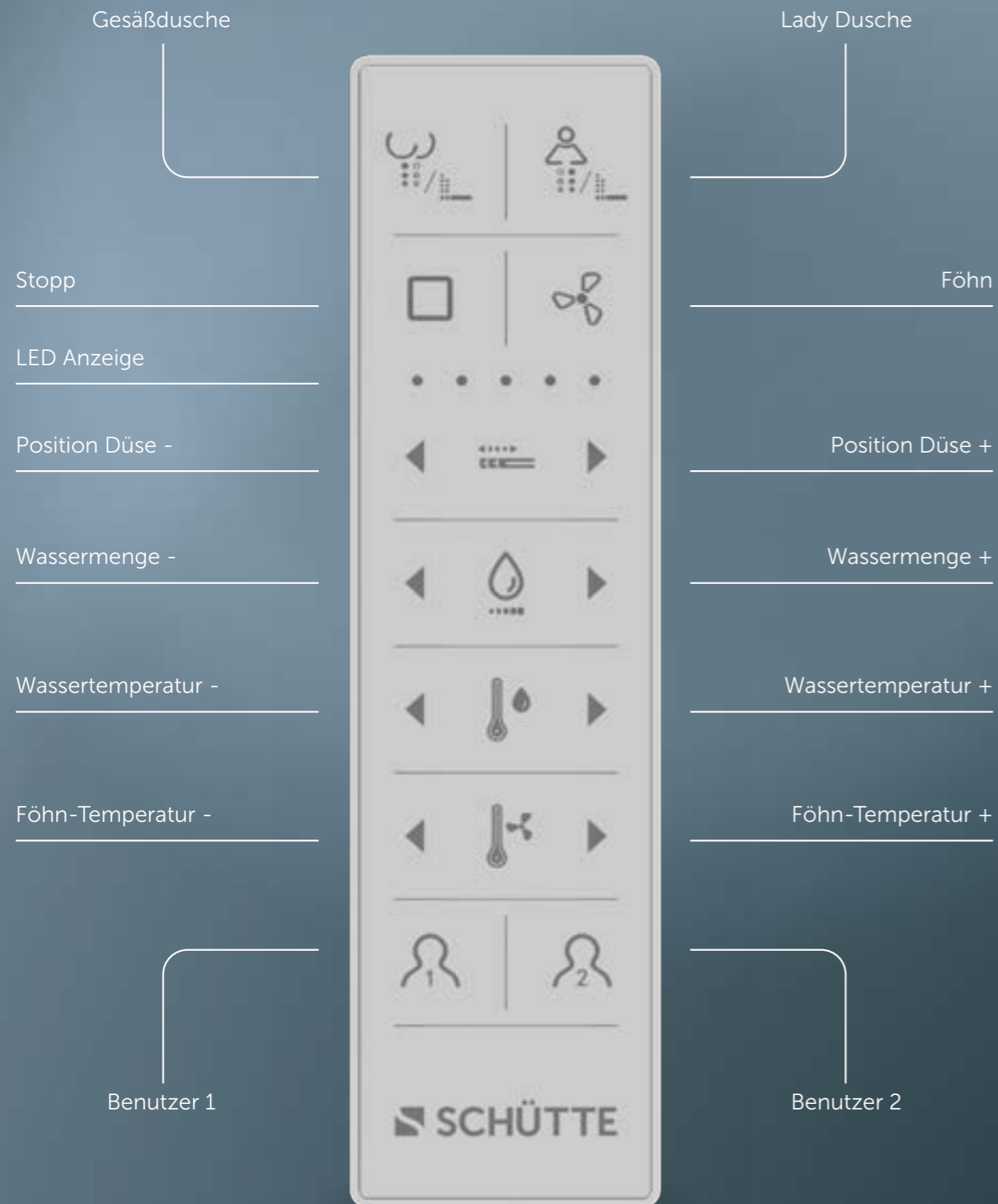

CESARI PREMIUM

W 93100 4008431931005





OWANO

W 93000 4008431930008



OWANO FERNBEDIENUNG

122355 4008431223551



ENTKALKER

250 ml 1200514 4008431090979



Plastikfreie Verpackung zum Schutz der Umwelt

EN | Plastic-free packaging to protect the environment
FR | Emballage sans plastique pour protéger l'environnement
NL | Plasticvrije verpakking voor een beter milieu



Maximale Belastbarkeit: x kg

EN | Maximum load capacity: x kg
FR | Capacité de charge maximale : x kg
NL | Maximaal draagvermogen: x kg



Geräuschloses Schließen dank Absenkautomatik

EN | Noiseless closing thanks to the soft closing hinges
FR | Fermeture silencieuse grâce aux charnières avec frein de chute
NL | Geruisloos sluiten dankzij de scharnieren met valrem



Einfaches Lösen dank Schnellverschluss

EN | Easy to remove thanks to the quick release hinges
FR | Retrait facile grâce aux charnières avec fonction déclipable
NL | Eenvoudig te verwijderen dankzij de afklikbare scharnieren

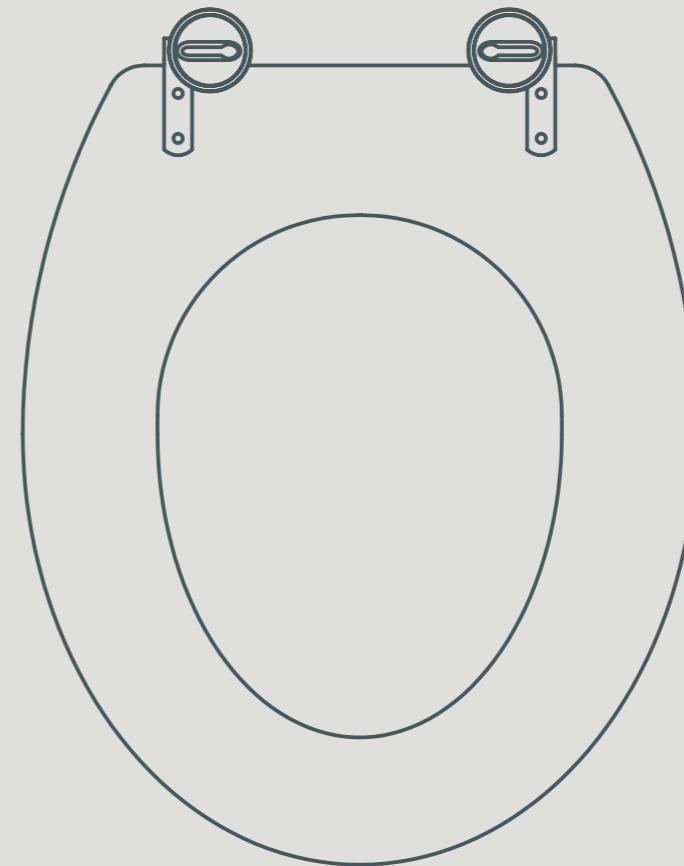

WC-SITZE

EN | TOILET SEATS
FR | ABATTANTS WC
NL | WC-ZITTINGEN

MDF

MDF

MDF ist die Abkürzung für mitteldichte Faserplatte. MDF-Platten haben in alle Richtungen ein gleichmäßiges Gefüge. Die MDF-Platten werden formgerecht zugeschnitten und haben eine besonders feine Oberfläche.

BAMBOO

BAMBUS

Bambus WC-Sitze werden aus echtem Bambus hergestellt. Bambus ist ein schnell nachwachsender und nachhaltiger Rohstoff. Durch eine Mehrschichtlackierung erhalten sie eine hygienische, pflegeleichte Oberfläche.

WOOD CORE

HOLZKERN

Besonders komfortabel und vor allem hautfreundlich, präsentieren sich WC-Deckel mit Holzkern. Das Material wird in die passende Form gepresst und hat eine besonders feine Oberfläche.

EN | MDF is the abbreviation for medium-density fibreboard. MDF boards have a uniform structure in all directions. The MDF boards are cut to shape and have a particularly fine surface.

FR | MDF est l'appellation pour panneaux de fibres de bois à densité moyenne. Les panneaux MDF présentent une structure homogène sous tous les angles. Découpés selon la forme requise, les panneaux MDF se caractérisent par une surface particulièrement douce.

NL | MDF is de benaming voor een middelzware vezelplaat. MDF-platen hebben een uniforme structuur in alle richtingen. De MDF-platen zijn in vorm gesneden en hebben een bijzonder fijn oppervlak.

EN | Bamboo toilet seats are made of real bamboo. Bamboo is a fast re-growing and sustainable raw material. A multi-layer lacquer finish gives you a hygienic, easy to clean surface.

FR | Les abattants WC en bambou sont fabriqués en bambou véritable. Le bambou est une matière première durable qui repousse rapidement. Plusieurs couches de vernis rendent la surface hygiénique et facile à entretenir.

NL | Bamboe WC-zittingen zijn gemaakt van echt bamboe. Bamboe is een snelgroeiende en duurzame grondstof. Een meerlaagse coating geeft ze een hygiënisch, onderhoudsvriendelijk oppervlak.

EN | Toilet seats with wooden core are especially comfortable and, above all, kind to the skin. The material is pressed into the right shape and has a particularly fine surface.

FR | Les abattants WC avec un noyau en bois sont particulièrement confortables et surtout agréables pour la peau. Le matériau pressé dans un moule à la forme souhaitée possède une surface particulièrement lisse.

NL | WC-zittingen met een houten kern zijn bijzonder comfortabel en vooral huidvriendelijk. Het materiaal wordt in de juiste vorm geperst en heeft een bijzonder fijn oppervlak.

DURO-PLAST

DUROPLAST

Duroplast WC-Sitze werden im Pressverfahren hergestellt. Das extrem harte, massive, durchgefärbte Material ist bruchstark und kratzfest. Die porenlos glatte Oberfläche macht die Pflege leicht.

EN | Duroplast toilet seats are manufactured in a pressure moulding process. The extremely hard, strong and thorough-coloured material is shatterproof and scratch resistant. The pore-smooth surface makes cleaning easy.

FR | Les abattants WC en duroplast sont fabriqués par un procédé de moulage sous pression. Ce matériau extrêmement dur, massif et coloré dans la masse est incassable et résistant aux rayures. La surface lisse facilite le nettoyage.

NL | Duroplast WC-zittingen worden vervaardigd in een drukgietsproces. Het extreem harde, sterke en doorgekleurde materiaal is onbreekbaar en krasbestendig. Het gladde oppervlak zonder poriën maakt het onderhoud eenvoudig.

THERMO-PLASTIC

THERMOPLAST

Thermoplast WC-Sitze bestehen aus besonders leichtem, formstabilem Kunststoff. Das Material ist recyclingfähig und überzeugt durch seine außergewöhnliche Bruchstarkheit.

EN | Thermoplastic toilet seats are made from particularly lightweight, dimensionally stable plastic. The material is recyclable and impresses with its exceptional break resistance.

FR | Les abattants WC en thermoplastique sont fabriqués à partir d'un plastique particulièrement léger et stable. Ce matériau est recyclable et se distingue par sa résistance exceptionnelle à la rupture.

NL | Thermoplast WC-zittingen zijn gemaakt van bijzonder licht en vormvast kunststof. Het materiaal is recyclebaar en overtuigt door zijn uitzonderlijke breukvastheid.

HIGH GLOSS

Unsere High Gloss WC-Sitze überzeugen durch ihre hochglänzende Oberfläche und perfekte Verarbeitung.

EN | Our High Gloss toilet seats impress with their ultra-shiny surface and perfect finish.

FR | Nos abattants WC High Gloss vous garantissent une surface brillante et une finition parfaite.

NL | Onze High Gloss WC-zittingen overtuigen door hun hoogglossoppervlak en perfecte afwerking.

PREMIUM

Unsere Premium WC-Sitze zeichnen sich durch besonders hochwertige Scharniere und eine exzellente Verarbeitung aus.

EN | Our premium toilet seats stand out with exceptionally high-quality hinges and outstanding craftsmanship.

FR | Nos abattants WC haut de gamme se distinguent par des charnières de très haute qualité et une finition irréprochable.

NL | Onze premium wc-brillen kenmerken zich door bijzonder hoogwaardige scharnieren en een uitstekende afwerking.

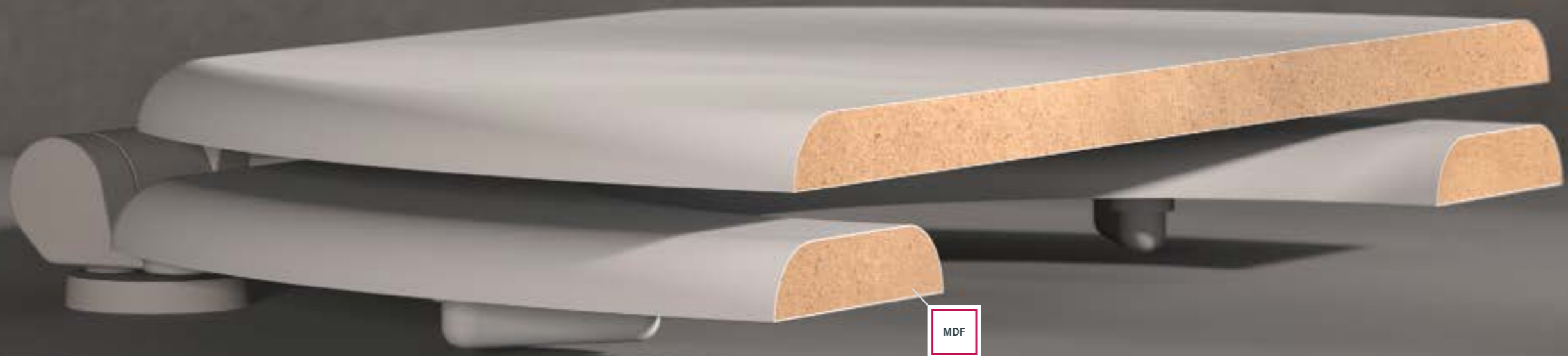



MDF
HIGH GLOSS

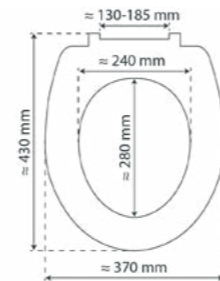

MDF

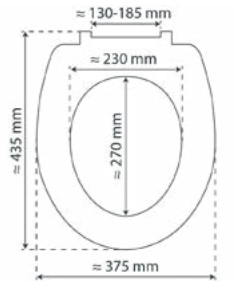

80522 4008431805221



80523 4008431805238



80535 4008431805351



80536 4008431805368



80541 4008431805412



80543 4008431805436



80545 4008431805450

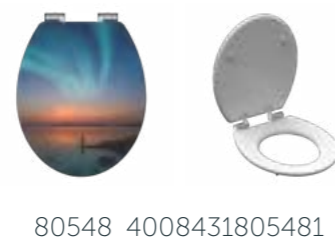

80548 4008431805481



80549 4008431805498



80101 4008431801018

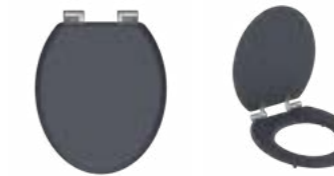

80104 4008431801049



80106 4008431801063



80120 4008431801209

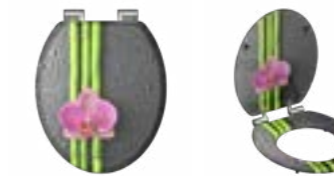

80121 4008431801216



80122 4008431801223



80123 4008431801230



80124 4008431801247



80127 4008431801278



80130 4008431801308



80131 4008431801315

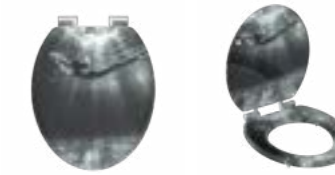

80135 4008431801353



80192 4008431801926



80193 4008431801933

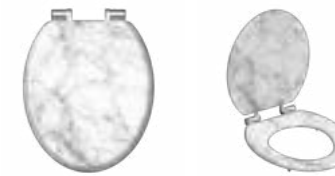

80194 4008431801940



MDF

175 kg



BAMBOO

175 kg



80022 4008431800226



80023 4008431800233



80024 4008431800240



81101 4008431811017



80027 4008431800271



BAMBOO

175 kg



81001 4008431810010



WOOD CORE

175 kg

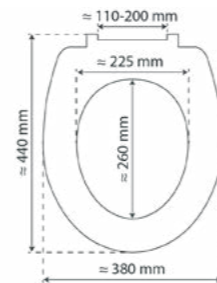

84100 4008431841007



WOOD CORE

175 kg

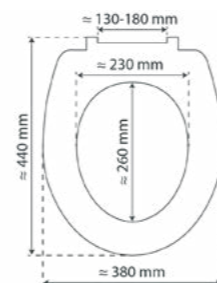

84000 4008431840000



DURO-PLAST

PLASTIC FREE PACKAGING
EMBALLAGE SANS PLASTIQUE

175 kg

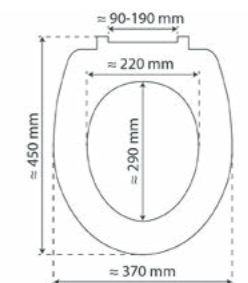

82950 4008431829500



DURO-PLAST

PLASTIC FREE PACKAGING
EMBALLAGE SANS PLASTIQUE

175 kg

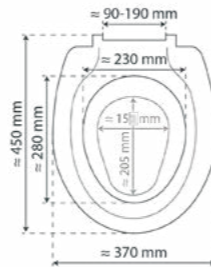

82940 4008431829401



DURO-PLAST

PLASTIC FREE PACKAGING
EMBALLAGE SANS PLASTIQUE

175 kg

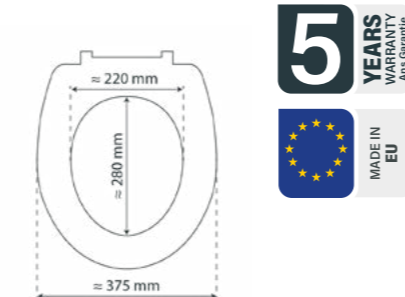

5 YEARS WARRANTY
Garantie 5 ans

MADE IN EU



82850 4008431836300



WC-SITZ INKL. DUFTSTEIN

GB | Toilet seat incl. deodorizer
FR | Abattant WC incl. bloc désodorisant
NL | Wc-bril incl. geurblokje

WC-SITZE FÜR MARKEN-KERAMIKEN

WC SEATS FOR BRAND-NAME CERAMICS | SIÈGES DE WC POUR CÉRAMIQUES DE MARQUE | WC-BRILLEN VOOR MERKKERAMIEK

DURO-PLAST

PLASTIC FREE PACKAGING
EMBALLAGE SANS PLASTIQUE

250 kg

5 YEARS WARRANTY
Garantie 5 ans

MADE IN EU

Unsere PRO WC-Sitze sind ideal auf bekannte Marken-Keramiken abgestimmt, sodass sie perfekt passen. Damit sorgen sie für Komfort und eine harmonische Optik in Ihrem Bad.

GB | Our PRO toilet seats are ideally matched to well-known brand ceramics so that they fit perfectly. This ensures comfort and a harmonious look in your bathroom.

FR | Nos abattants de WC PRO sont idéalement adaptés aux céramiques de marques connues, de sorte qu'ils s'adaptent parfaitement. Ils assurent ainsi un confort et un aspect harmonieux dans votre salle de bains.

NL | Onze PRO toiletzittingen zijn ideaal afgestemd op keramiek van bekende merken, zodat ze perfect passen. Dit zorgt voor comfort en een harmonieuze uitstraling in je badkamer.



PRO 1

82800 4008431828008

Geberit Virto
Ideal Standard Eurovit
Laufen Objekt
Villeroy & Boch Arriba



PRO 2

82810 4008431828107

Laufen Pro
Villeroy & Boch O Novo
Vitra S50



PRO 3

82811 4008431828114

Geberit Renova
Laufen Moderna



PRO 4

82820 4008431828206

Geberit Renova Plan



PRO 5

82812 4008431828121

Villeroy & Boch Subway 1
Villeroy & Boch Omnia Architectura
Villeroy & Boch Architectura



PRO 6

82813 4008431828138

Geberit Icon
Duravit DuraStyle Basic



PRO 7

82814 4008431828145

Geberit Icon



PRO 8

82815 4008431828152

Duravit Starck 3
Duravit Me by Starck



PRO 9

82801 4008431828015

Villeroy & Boch Omnia

PREMIUM WC-SITZE

PREMIUM WC SEATS | SIÈGES WC PREMIUM | PREMIUM WC-STOELEN

DURO-PLAST PREMIUM

PLASTIC FREE PACKAGING
EMBALLAGE SANS PLASTIQUE

250 kg

5 YEARS WARRANTY
5 ANS GARANTIE

Unsere Premium WC-Sitze zeichnen sich durch besonders hochwertige Scharniere und eine exzellente Verarbeitung aus.

GB | Our premium toilet seats stand out with exceptionally high-quality hinges and outstanding craftsmanship.

FR | Nos abattants WC haut de gamme se distinguent par des charnières de très haute qualité et une finition irréprochable.

NL | Onze premium wc-brillen kenmerken zich door bijzonder hoogwaardige scharnieren en een uitstekende afwerking.



82600 4008431823102



82630 4008431826301



82610 4008431626109



82650 4008431826509



DURO-PLAST HIGH GLOSS

PLASTIC FREE PACKAGING
EMBALLAGE SANS PLASTIQUE

175 kg

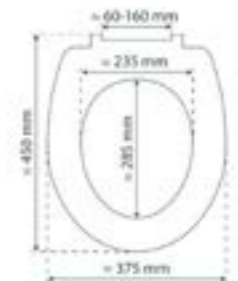

82580 4008431825809



82581 4008431825816



82582 4008431825823

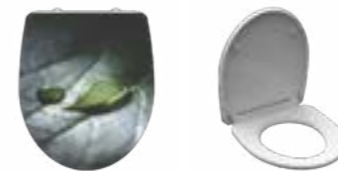

82583 4008431825830



82584 4008431825847

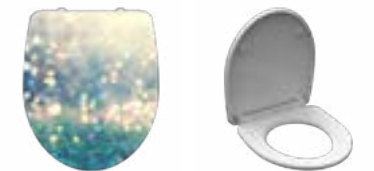

82587 4008431825878



› 82710 4008431827100

DURO-PLAST

PLASTIC FREE PACKAGING
EMBALLAGE SANS PLASTIQUE

175 kg



DURO-PLAST

PLASTIC FREE PACKAGING
EMBALLAGE SANS PLASTIQUE

175 kg



82700 4008431827001



82702 4008431827025



82704 4008431827049



82300 4008431823003



82302 4008431823027



82304 4008431823041



82910 4008431829104

DURO-PLAST

PLASTIC FREE PACKAGING
EMBALLAGE SANS PLASTIQUE

175 kg



82305 4008431823058



82360 4008431823607



82363 4008431823638



82365 4008431823652



82367 4008431823676



82368 4008431823683

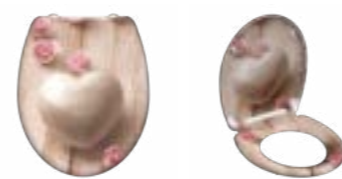

82370 4008431823706

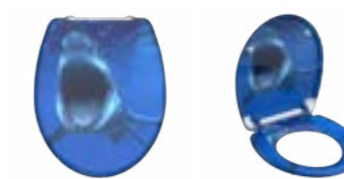

82371 4008431823713

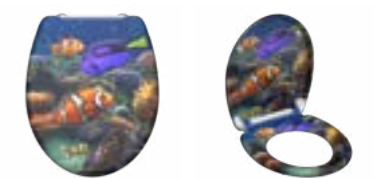

82372 4008431823720



82373 4008431823737

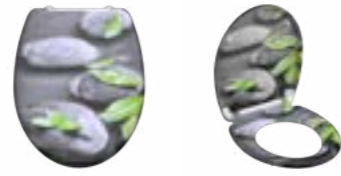

82374 4008431823744



82376 4008431823768



82377 4008431823775



82378 4008431823782



82380 4008431823805



82381 4008431823812

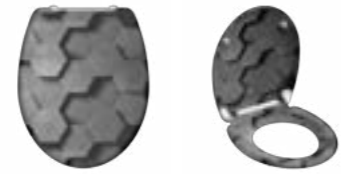

82392 4008431823928

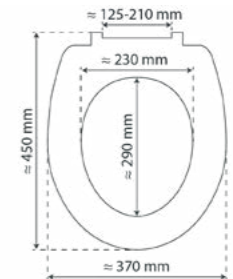

82100 4008431821009



82148 4008431821481



82149 4008431821498

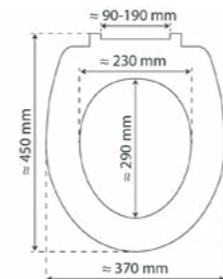

82152 4008431821528

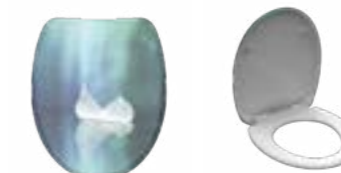

82153 4008431821535

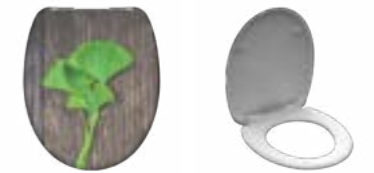

82154 4008431821542

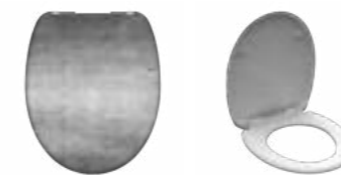

82155 4008431821559



82157 4008431821573



82190 4008431821900



82410 4008431824109

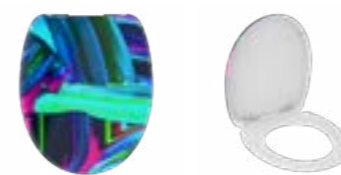

82191 4008431821917



82196 4008431821962



82197 4008431821979



DURO-PLAST

PLASTIC FREE PACKAGING
EMBALLAGE SANS PLASTIQUE

175 kg

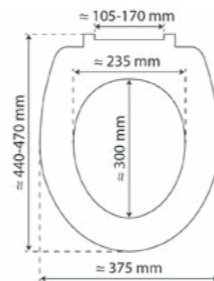

10220 4008431102207



DURO-PLAST

PLASTIC FREE PACKAGING
EMBALLAGE SANS PLASTIQUE

175 kg

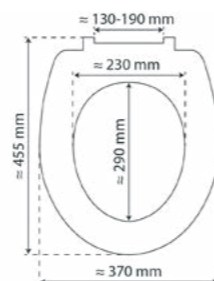

82000 4008431820002

PREMIUM WC-SITZE

PREMIUM WC SEATS | SIÈGES WC PREMIUM | PREMIUM WC-STOELEN

THERMO-PLASTIC PREMIUM

PLASTIC FREE PACKAGING
EMBALLAGE SANS PLASTIQUE

300 kg

5 YEARS WARRANTY
5 ANS GARANTIE

Unsere Premium WC-Sitze zeichnen sich durch besonders hochwertige Scharniere und eine exzellente Verarbeitung aus.

GB | Our premium toilet seats stand out with exceptionally high-quality hinges and outstanding craftsmanship.

FR | Nos abattants WC haut de gamme se distinguent par des charnières de très haute qualité et une finition irréprochable.

NL | Onze premium wc-brillen kenmerken zich door bijzonder hoogwaardige scharnieren en een uitstekende afwerking.



83310 4008431833101

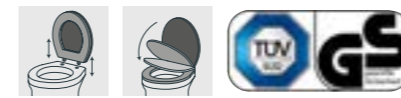

83630 4008431836300

